

## *Latent*

### Pipe Duct & Accessories - Wall & Roof Brackets

#### ***Latent*** - Duct & Accessories

- Latent duct and accessories are made of rigid P.V.C which offers a never changing aspect. The duct and accessories are fade-proof, U.V resistant and fireproof.
- Thanks to the advantage of P.V.C and its linear structure, they are very harmonious with any type of construction or building offering an outstanding quality finish.
- The easy to install ducts have a bottom and upper section. The bottom is first fixed to the wall. Then you fix the pipe, wiring and bind them with the Tie Clip (that slides along the inside rail). Finally cover them with the snap on upper section.
- All accessories that are two part are supplied with stainless steel screws to prevent rusting and unsightly stains.
- Mounting blocks will support upto 240Kg. Each mount is supplied with 2 x bolts, nuts & washers. End caps and galvanised tie down setting plates are available to suit.



#### ***Latent*** - Wall & Roof Brackets

- Wall & roof adjustable brackets are made from galvanised powder coated steel.
- Mount pads are made from E.P.D.M. which is an outstanding ultraviolet & weather resistant material.
- Three wall bracket sizes:
  - 60 Kg
  - 80 Kg
  - 150 Kg
- Composite Corrosion Free Wall Bracket
  - 80 Kg
- Roof brackets are adjustable from 3 to 30 degrees and have a load rating of 80 Kg.

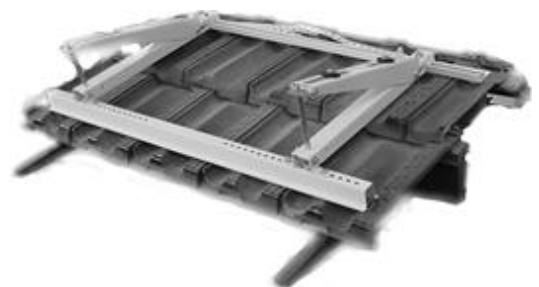
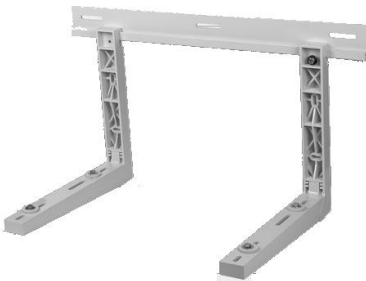

# LATENT DUCTS & ACCESSORIES

## Pipe Ducts

Airefrig Part Number	Description	Dimensions mm	List Price Excl GST
D70	70 Pipe Duct	70 x 65 x 2000	\$31.77
D105	105 Pipe Duct	105 x 75 x 2000	\$51.55
D150	150 Pipe Duct	150 x 80 x 2000	\$61.83

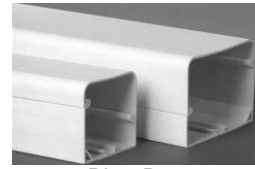

Pipe Duct

## Pipe Duct Fittings

Airefrig Part Number	Description	Dimensions mm	List Price Excl GST
EIN70	Elbow in Corner	95 x 95 x 70	\$12.35
EIN105		110 x 110 x 105	\$25.67
EIN150		125 x 125 x 150	\$30.92
EB70	Elbow Bend	95 x 95 x 70	\$11.75
EB105		110 x 110 x 105	\$21.81
EB150		125 x 125 x 150	\$30.92
FB70	Flat Bend 90 Deg	115 x 115 x 70	\$11.75
FB105		150 x 150 x 105	\$20.13
FB150		165 x 165 x 150	\$28.42
FB70ADJUST	Flat Bend Adjustable	Adjustable between 45 to 90 Deg	\$14.53
FB105ADJUST			\$26.81
FB7045	Flat Bend 45 Deg	92 x 145 x 70	\$11.75
FB10545		92 x 170 x 105	\$21.38
FB15045		80 x 187 x 150	\$28.42
DE70	Duct End	120 x 70 x 45	\$7.89
DE105		120 x 105 x 50	\$12.25
DE150		150 X 150 X 53	\$13.57
DC70	Duct Cap	70 x 65 x 2	\$6.93
DC105		105 x 75 x 2	\$7.82
CP70	Connection Piece	75 X 70 X 60	\$4.68
CP105		110 x 80 x 60	\$7.43
CP150		155 x 90 x 60	\$12.00
RJ70105	Reducer Joint	105 x 80 x 70	\$9.35
RJ105150		150 X 85 X 105	\$12.00
TJ105	Tee Joint	105 x 105 x 200	\$44.66
TJ150		150 X 150 X 245	\$59.90
WC70	Wall Cover	110 x 180 x 70	\$11.39
WC105		145 x 190 x 105	\$20.24
WC150		235 x 150 x 150	\$31.56
FJ70	Flexible Joint	500 x 65 x 65	\$10.71
FJ105		500 x 100 x 100	\$18.81
WR70	Wall Rosette	115 x 110 x 70	\$7.25
WR105		150 x 120 x 105	\$8.28
WR150		195 x 125 x 150	\$9.50
FR70	Flat Rosette	115 x 90 x 70	\$6.43
FR105		150 x 100 x 105	\$6.43
FR150		195 x 105 x 150	\$8.18
TCLIP	Tie Clip		\$1.75

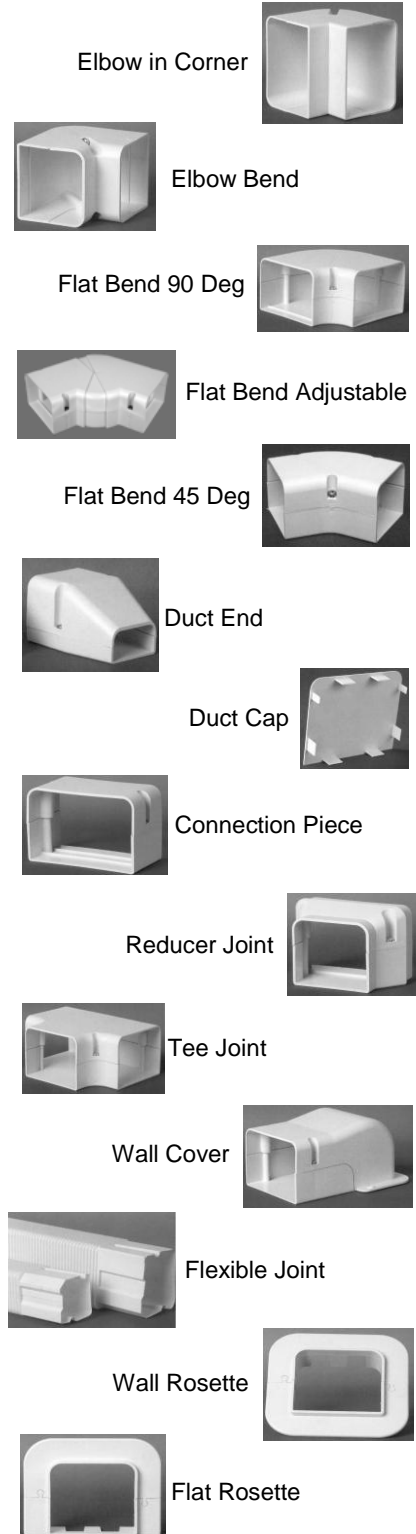

Elbow in Corner



Elbow Bend

Flat Bend 90 Deg

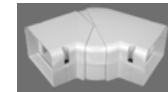

Flat Bend Adjustable

Flat Bend 45 Deg



Duct End

Duct Cap

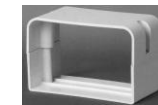

Connection Piece

Reducer Joint

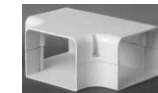

Tee Joint

Wall Cover

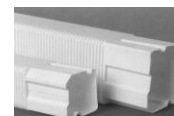

Flexible Joint

Wall Rosette



Flat Rosette

# LATENT DUCTS & ACCESSORIES

## Mountbloccs

Airefrig Part Number	Description	Dimensions mm	List Price Excl GST
EXW38	White Mountbloc Supports 240Kg each (2 Mounts Per Set)	105 x 95 x 350	\$23.54
EXBW38		105 x 95 x 450	\$29.26
EXWA38		105 x 95 x 1000	\$41.00
INJW181	White End Caps suit Mountbloccs (4 Caps Per Set)		\$13.47
A12	Anchor Set suit Mountbloccs (4 Anchors Per Set)		\$34.99
AEROSTAND075	Machinery Mount (4 Stands Per Set) Max Load 50Kg per stand	100 x 50 x 75	\$20.22



EXW38



INJW181



AEROSTAND075



A12

## Drain Pipe Duct & Fittings

Airefrig Part Number	Description	Dimensions mm	List Price Excl GST
DPD	Drain Pipe Duct	32 x 30 x 2000	\$9.14
DPCI	Drain Pipe In Corner	35 x 32 x 57	\$2.03
DPCO	Drain Pipe Corner Out	35 x 32 x 47	\$2.03
DPFE	Drain Pipe Flat Elbow	35 x 32 x 65	\$2.03
DPC	Drain Pipe Connector	35 x 32 x 30	\$2.03
DPWC	Drain Pipe Wall Cover	35 x 32 x 63	\$2.03
DP96ROLL	Drain Pipe (50mtr Roll)	16, 18 & 20mm connections	\$61.87
DP96MTR	Drain Pipe (per metre option)	16, 18 & 20mm connections	\$1.72
CCY	"Y" Piece Connector	16 x 18 x 20	\$1.18

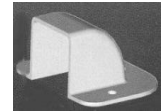
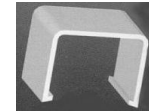
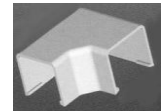
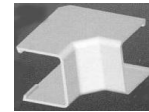
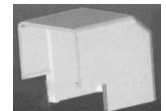

## Wall & Roof Brackets

Airefrig Part Number	Description	Maximum Load Kg	Dimensions (L x D x H) mm	List Price Excl GST
EJP60	Adjustable Wall Bracket	60	700 x 380 x 450	\$86.04
EJP80		80	1050 x 490 x 590	\$98.08
ME150		150	750(H) x 650(D)	\$141.96
SBP46PUL	Composite Wall Bracket	80	790 x 460 x 410	\$137.08
EJPRB80	Adjustable Roof Bracket	80	1050 x 590 x 350	\$172.08

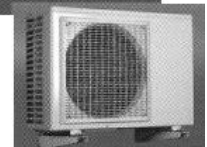
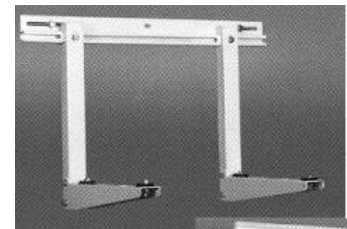

Roof Bracket, adjustable angle 3 to 30 degrees.

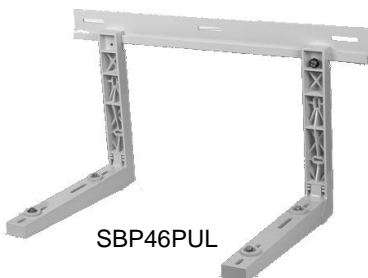

SBP46PUL

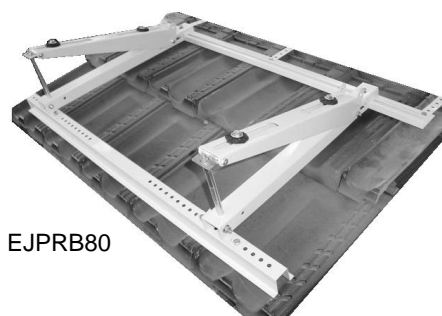

EJPRB80

# INOAC DUCTS & ACCESSORIES



## Pipe Duct & Accessories

### INOAC - Duct & Accessories

- Inoac's duct and large range of accessories will save contractors time due to ease of installation plus ensures a perfect & professional finish.
- Inoac duct and accessories are made of rigid P.V.C which offers a never changing aspect. The duct and accessories are fade-proof and U.V resistant.
- Thanks to the advantage of P.V.C and its linear structure, they are very harmonious with any type of construction or building offering an outstanding quality finish.
- The easy to install ducts have a bottom and upper section - the bottom is first fixed to the wall. Then fit the pipe, wiring and bind them with the duct saddle tie clips & finally cover them with the snap on upper section.
- All accessories that are two part are supplied with stainless steel screws to prevent rusting and unsightly stains.

#### Pipe Duct (Ivory)

Airefrig Part Number	Description	Duct Size	Dimensions (mm)					Pcs/box	List Price Excl GST
			A	B	C	D	E		
CD75	Pipe Duct	75	75.5	64	2000	-	-	5	\$25.54
CD100		100	100	70	2000	-	-	5	\$32.59
CD140		140	140	80	2000	-	-	5	\$38.98

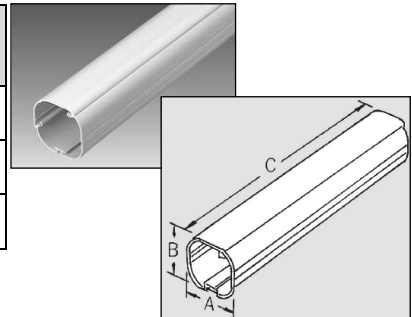

#### Accessories (Ivory)

Airefrig Part Number	Description	Duct Size	Dimensions (mm)					Pcs/box	List Price Excl GST
			A	B	C	D	E		

NY75	Wall Cover	75	84	67	210	130	83	40	\$5.66
NY100		100	106	70	230	141	93	20	\$10.30
NY140		140	146	80	285	182	102	5	\$17.30

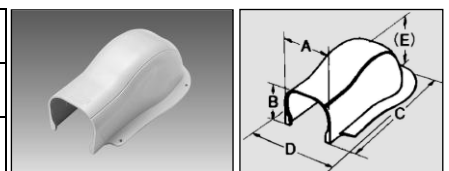

NA75	Corner Cap	75	84	70	66	124	124	20	\$5.15
NA100		100	109	76	66	149	140	20	\$7.22
NA140		140	148	86	66	189	155	10	\$7.78

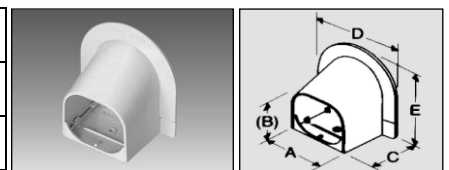



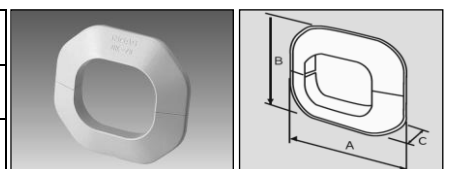



NK75	Wall Cap	75	126	114	16	-	-	80	\$3.70
NK100		100	175	145	16	-	-	40	\$6.05
NK140		140	220	180	16	-	-	20	\$7.73

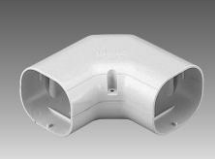
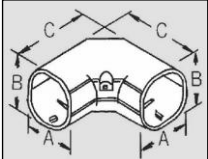

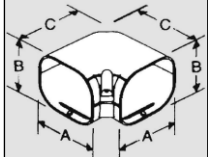
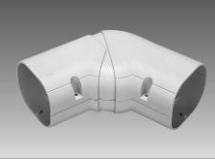
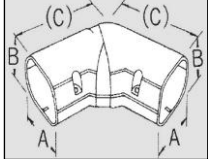
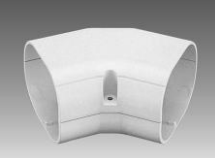
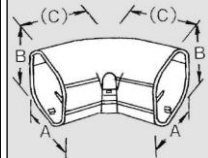
# INOAC DUCTS & ACCESSORIES

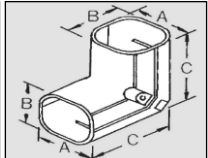
## Accessories (Ivory) cont'd

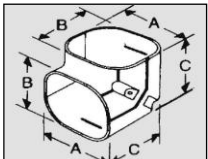
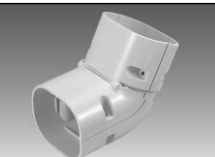
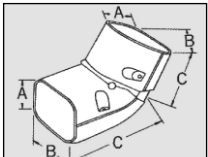
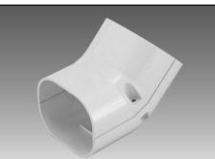
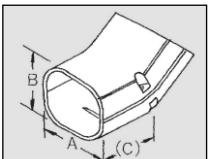
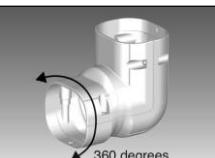
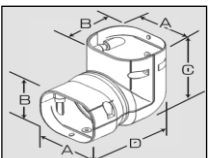
Airefrig Part Number	Description	Duct Size	Dimensions (mm)					Pcs/box	List Price Excl GST		
			A	B	C	D	E				
NE75	Elbow 90° (Horizontal)	75	82	69	141	-	-	40	\$9.97		
NE100		100	107	75	161	-	-	20	\$12.15		
NE140		140	146	85	200	-	-	5	\$18.70		
NH75	Mini Elbow 90° (Horizontal)	75	82	69	100	-	-	40	\$5.71		
NH100		100	107	75	125	-	-	20	\$8.29		
NH140		140	146	85	165	-	-	5	\$13.05		
NX75	Elbow 45° to 90° Adjustable (Horizontal)	75	82	69	153	-	-	40	\$7.73		
NX100		100	107	75	193.5	-	-	20	\$13.55		
NX140		140	146	85	248	-	-	5	\$19.21		
NM75	Elbow 45° (Horizontal)	75	82	69	74	-	-	40	\$6.22		
NM100		100	107	75	84	-	-	20	\$8.34		
NM140		140	146	85	106	-	-	5	\$12.32		
NC75	Elbow 90° (Vertical)	75	82	69	124	-	-	40	\$7.67		
NC100		100	107	75	135	-	-	20	\$12.21		
NC140		140	146	85	149	-	-	5	\$15.23		
NL75	Mini Elbow 90° (Vertical)	75	82	69	83	-	-	10	\$8.79		
NL100		100	107	75	90	-	-	5	\$10.58		
NL140		140	146	85	100	-	-	5	\$12.10		
NZ75	Elbow 45° to 90° Adjustable (Vertical)	75	82	69	122	-	-	40	\$8.40		
NZ100		100	105	73	117	-	-	5	\$10.08		
NZ140		140	146	87	150	-	-	5	\$13.22		
NU75	Elbow 45° (Vertical)	75	82	69	72	-	-	40	\$5.10		
NU100		100	107	75	83	-	-	20	\$6.27		
NU140		140	146	85	93	-	-	10	\$13.78		
NCX75	Elbow twists 360° (For Vertical or Horizontal use)	75	80	68	114	-	-	10	\$6.10		
NCX100		100	107	75	135	-	-	20	\$10.08		
NCX140		140	146	87	190	-	-	5	\$15.51		

# INOAC DUCTS & ACCESSORIES

## Accessories (Ivory) cont'd

Airefrig Part Number	Description	Duct Size	Dimensions (mm)					Pcs/box	List Price Excl GST
			A	B	C	D	E		

NT75	T-Joint	75	82	69	121	160	25	10	\$13.78
NT100	c/w 2 x reducers 100 to 75 (NT100)	100	107	75	161	210	35	5	\$17.98
NT140	c/w 2 x reducers 100 to 75 (NT140)	140	146	85	200	254	35	5	\$27.72

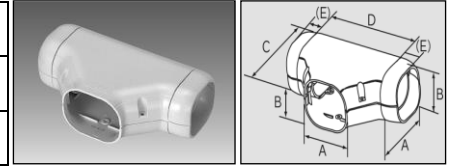

NR75	Duct End Socket	75	53	30	99	82	69	40	\$4.14
NR100		100	53	30	115	107	75	20	\$5.77
NR140		140	53	30	143	146	85	10	\$8.51

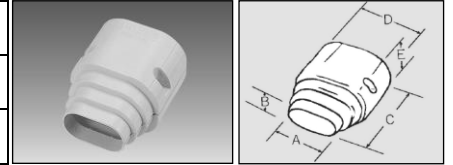

NS75	Duct Connector Socket	75	82	69	80	-	-	40	\$3.14
NS100		100	107	75	80	-	-	20	\$6.10
NS140		140	146	85	80	-	-	10	\$6.16

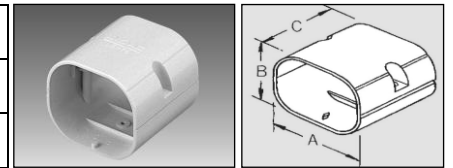

NJ75100	Duct Reducer Socket	75 to 100	86	72	80	107	75	40	\$5.26
NJ100140		100 to 140	115	78	80	146	85	40	\$7.17

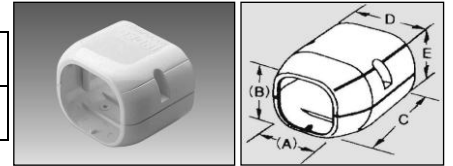

NF75	Flexible Joint  (made from Polyethylene)	75	76	64	60	550	-	10	\$6.78
NF75M		75	76	64	60	1000	-	10	\$10.81
NF100		100	101	70	75	800	-	10	\$13.61
NF140		140	140	80	80	1000	-	5	\$29.68

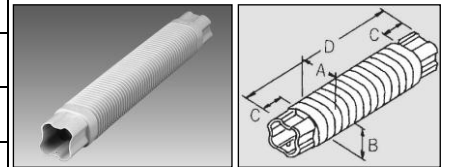

NQF75	Twisted & Flexible Elbow	75	76	6	1000	8	-	5	\$23.02
NQF100		100	101	6	1000	10	-	5	\$28.17

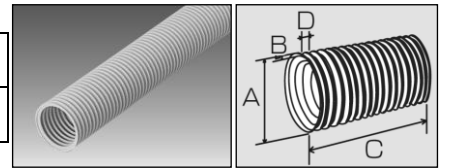

NQ75	Twisted Elbow Socket	75	82	69	90	85.5	-	10	\$6.66
NQ100		100	107	75	102	94	-	5	\$12.60

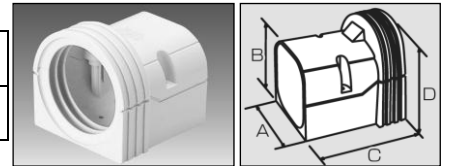

NQJ75	Twisted Elbow Joint	75	88	54	-	-	-	10	\$6.72
NQJ100		100	113	63	-	-	-	5	\$9.41

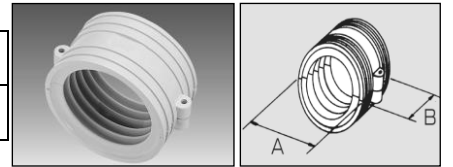

NVS	Duct Saddle Clip & Tie	75	250mm (long) nylon tie					500	\$2.35
NVL		100 & 140	360mm (long) nylon tie					500	\$2.80



# INOAC DUCTS & ACCESSORIES

## Accessories (cont'd)

Airefrig Part Number	Description	Colour	Maximum Load	Weight	Dimensions (mm)			Pieces per Box	List Price Excl GST
					Height	Width	Length		
DSD400N	Base Rock Stand (PVC resin)	Ivory	120kg (at +50°C)	670 grams	82	83	400	30	\$12.32
DSD1000N				1675 grams	82	83	1000	10	\$26.77

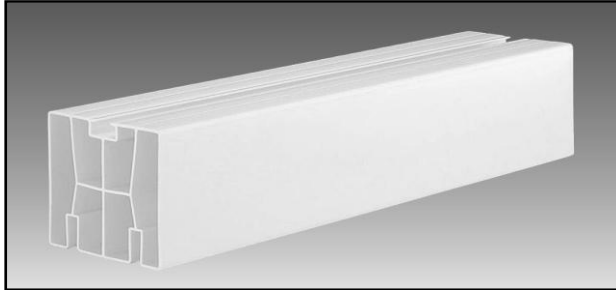

## Accessories (cont'd)

Airefrig Part Number	Description	Colour	Pieces per Box	List Price Excl GST
DSDEC	End Cap to suit the Base Rock Stands	Ivory	-	\$0.90

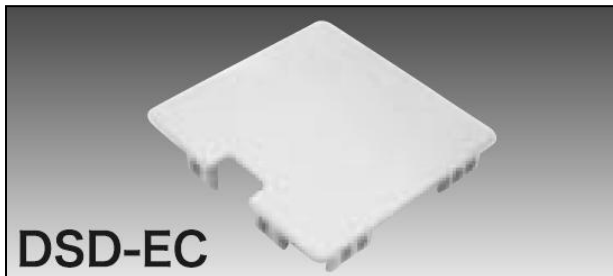

## Accessories (cont'd)

Airefrig Part Number	Description	Pieces per Box	List Price Excl GST
DSDMP	Metal Fixing Plate to suit the Base Rock Stands	-	\$0.73

