

ENGINEERING
TOMORROW

Danfoss

User Guide

Electronic refrigeration control Type **ERC 21X** series

Smart multipurpose refrigeration controller



Contents

Introduction	5
Application	5
General description	5
ERC 21X series	5
ERC 211	5
ERC 213	6
ERC 214	6
Functions	8
Voltage protection	8
Compressor protection	8
Compressor protection against high condensing temperature	8
Reference displacement	9
Night mode	9
Fan cycling during compressor OFF cycle	10
Defrost on Demand	10
Applications	11
Pre-defined applications	11
ERC 211 controller	11
ERC 213 controller	11
ERC 214 controller	12
Electrical connection diagram	12
Configuration	14
Menu navigation and overview	14
Quick configuration at power up	14
Quick configuration via cFg menu	15
Factory resetting	17
Display codes	17
Parameters	18
Parameter description	18
Configuration	18
Thermostat	18
Alarm settings	19
Defrost	19

Fan	20
Compressor	20
Miscellaneous	21
Service	22
Parameters: ERC 211	22
Configuration	22
Reference	23
Alarm	23
Defrost	23
Compressor	24
Others	24
Polarity	24
Parameters: ERC 213	24
Configuration	24
Reference	25
Alarm	25
Defrost	25
Fan control	26
Compressor	26
Others	26
Polarity	27
Parameters: ERC 214	27
Configuration	27
Reference	27
Alarm	28
Defrost	28
Fan control	28
Compressor	29
Others	29
Polarity	29
Alarm code	30
Product specification	31
Technical specification	31
Mounting	31
Installation steps	32
Dimensions	32
Accessories	32

KoolKey (EKA200)	32
Mass Programming Key (EKA 201)	32
Bluetooth Adapter (EKA 202 & EKA 203)	33
Ordering	34
Certificates, declarations, and approvals	35
Certificates, declarations, and approvals	35
Online support	36

Introduction

Application

ERC 21X is a smart multipurpose refrigeration controller designed to fulfill today's requirement of commercial refrigeration applications. This controller is suitable for high, medium and low temperature applications with natural, electrical and hot gas defrost compatibilities.

Typical applications include Glass door merchandisers, commercial fridges and freezers, cold rooms and various other commercial refrigeration applications.



General description

ERC 21X controller comes with four push buttons, a big display, easy and intuitive menu structure and pre-defined applications ensure ease of use. Controller is loaded with energy efficiency features like smart evaporator fan management, night mode and defrosts on demand features.

High capacity 16 A relay enable direct connection of heavy loads without use of intermediate relay: up to 2 hp compressors depending on its power factor and motor efficiency (power factor greater than 0.65 for 230 V and greater than 0.85 for 115 V).

Safe operation of the unit is ensured through voltage protection, zero cross switching and high condenser temperature protection features.

ERC 21X series

Three version of ERC 21X is available in both 230 V AC, 50/60HZ and 115 V AC, 60Hz.

- ERC 211: single relay output for refrigeration and heating applications.
- ERC 213: three relays outputs for ventilated refrigeration and heating applications.
- ERC 214: four relays outputs for ventilated refrigeration and heating applications.

ERC 211

ERC 211 has one relay output and two inputs (1 analogue, 1 analogue/digital). This controller can be used for either cooling or heating applications.

Figure 1: ERC 211

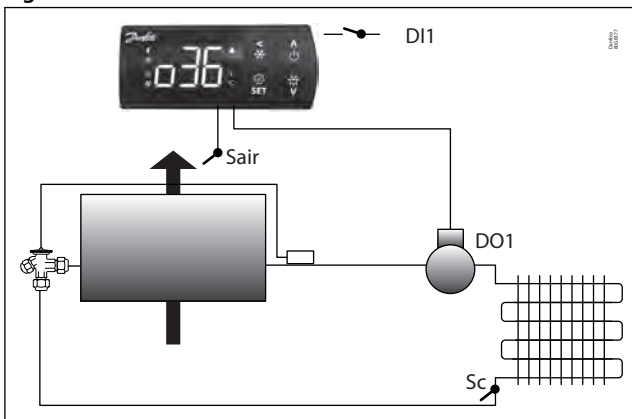

Outputs:

- Relay 1: compressor/solenoid valve control or simple heater in case of heating application.

Inputs:

- Input 1: control sensor (Sair).
- Input 2: condenser sensor or digital inputs that can be configured for various functions as mentioned under menu code o02.

ERC 213

ERC 213 has three relays outputs and four inputs (2 analogues, 1 analogue/digital, 1 digital) for cooling and heating applications.

Figure 2: ERC 213

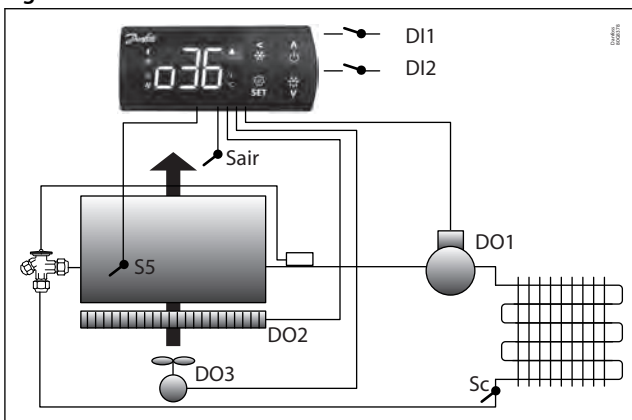

Outputs:

- Relay 1: compressor/solenoid valve control or heater in case of heating applications
- Relay 2: can be configured defrost control or external alarm or cabinet light
- Relay 3: fan control

Inputs:

- Input 1: control sensor (Sair)
- Input 2: defrost sensor (S5)
- Input 3: condenser sensor (Sc) or digital input that can be configured for various functions as mentioned under menu code o02
- Input 4: digital input that can be configured for various functions as mentioned under menu code o37

ERC 214

ERC 214 has four relays outputs and four inputs (2 analogue, 1 analogue/digital, 1 digital) for cooling applications.

Figure 3: ERC 214

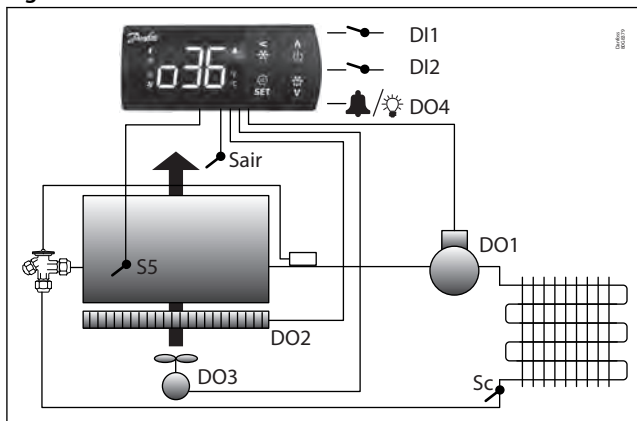

Outputs:

- Relay 1: compressor/solenoid valve control
- Relay 2: defrost control, external alarm or cabinet light
- Relay 3: fan control
- Relay 4: this can be configured for either cabinet light or external alarm

Inputs:

- Input 1: control sensor (Sair)
- Input 2: defrost sensor (S5)
- Input 3: condenser sensor (Sc) or digital input that can be configured for various functions as mentioned under menu code o02
- Input 4: digital input that can be configured for various functions as mentioned under menu code o37

Functions

Voltage protection

The voltage protection ensures that the compressor motor is operating within safe voltage ranges. If the power supply voltage gets outside the specified high/low voltage cut-out ranges, the compressor is cut-out or restricted from starting. Normal compressor operation is resumed when the power supply voltage is back in the area between the high voltage cut-out limit and the low voltage cut-in limit.

Figure 4: Voltage protection

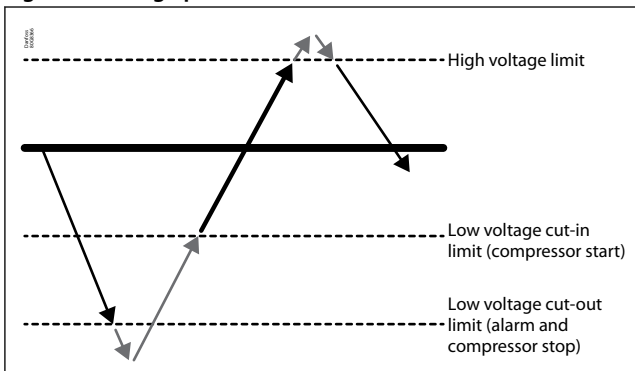

Compressor protection

Compressor protection feature protects compressor from short ON and OFF cycles by securing minimum run and stop time. This would allow the refrigeration system to stabilize before starting the compressor again and also avoid the chances of too many compressor cycles.

Figure 5: Compressor protection

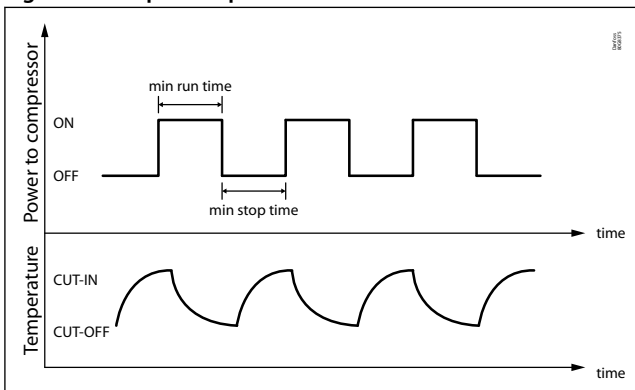

Compressor protection against high condensing temperature

If the condenser is blocking up with dirt and thereby reaches a too high condensing temperature, the controller will give the user early warning through condenser alarm and if temperature rises further, it will switch the compressor OFF. If the temperature measured by the condenser sensor (Sc) is reaching the set "pre-alarm limit" an alarm is raised, but no further action is taken. This is used to indicate to the user that something is wrong with the condenser. Often the reason is that the air flow to the condenser is restricted (dirt) or because the condenser fan is broken.

The alarm will reset if the condenser temperature drops back by 5 °C. If the measured condenser temperature continues to increase and reaches the set "Block limit" the compressor is stopped, and it is restricted from starting again until the alarm is reset manually. The alarm can be reset manually by setting the parameter r12 Main switch to OFF position and back to ON position or by powering the controller down.

Figure 6: Compressor protection against high condensing temperature

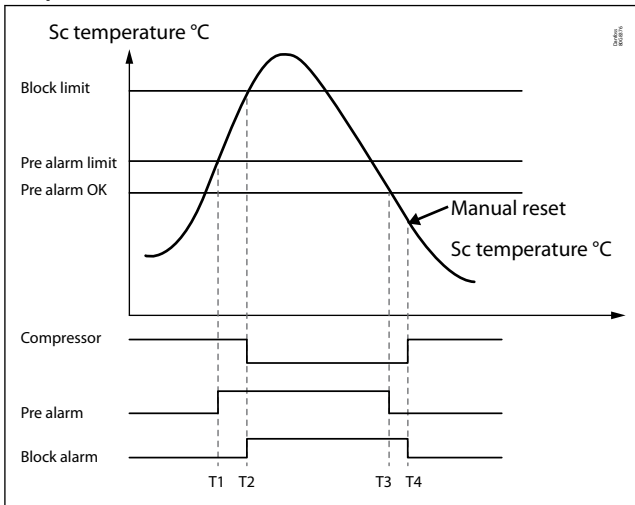

Reference displacement

This feature enable user to toggle between two different set-points quickly by activating a switch on digital input. This provides facility to switch between two storage temperatures without getting in to the menu. For example meat requires different set points than vegetables. The reference displacement signal changes the normal thermostat set-point and the alarm limits by a predefined reference displacement offset value (r40).

Figure 7: Reference displacement

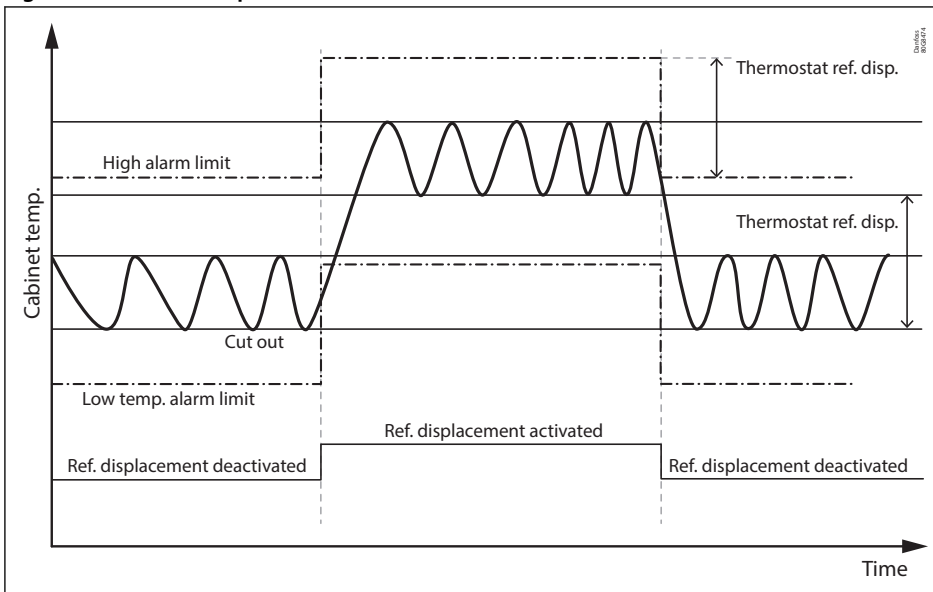

Night mode

Night mode helps to reduce cooling load and thereby power consumption during non-business hours i.e., Night time. The thermostat set point will be offset by a fixed value during night mode keeping alarm limits same.

Figure 8: Night mode

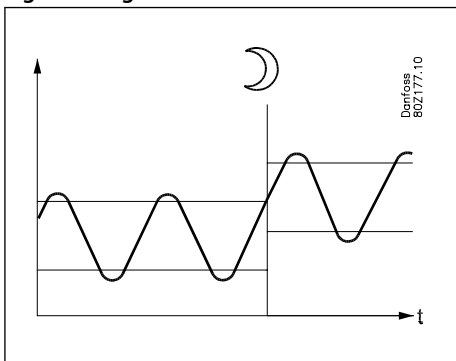

Fan cycling during compressor OFF cycle

During compressor OFF cycle controller will run the fan with defined duty cycle to maintain uniform temperature and delay the need of compressor switching ON.

Figure 9: Fan cycle

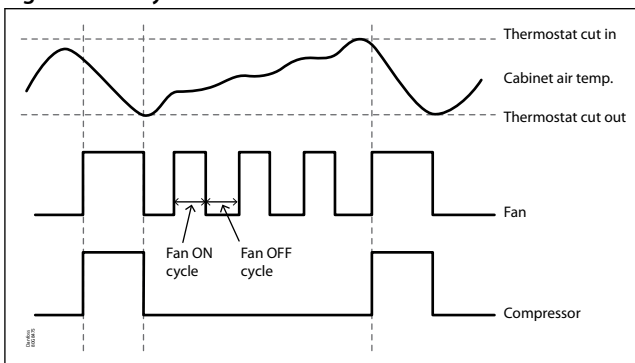

Defrost on Demand

This feature records the evaporator temperature when it is clean and constantly monitors the compares that at every compressor cut outs. If the evaporator temperature goes below the recorded temperature by the value set in parameter d30 before the configured defrost interval, it will trigger defrost immediately.

- This function can only be used in 1:1 systems.
- This function is disabled when the parameter “d30” is set to 20.
- Defrost on demand is triggered only if the time since the last defrost session has ended is greater than ¼ of the defrost interval or 2 hours whichever is lesser.
- Defrost doesn’t start by this method during the following scenarios.
 - Pull down mode
 - Night mode
 - Main switch in DI or main switch in Menu is in OFF position
 - Manual control mode
 - Evaporator temperature greater than 0 °C.

Applications

Pre-defined applications

The purpose of the pre-defined applications is to give the user an easy and fast way to configure the controller to a specific application based on storage temperature (LT, MT, HT), defrost type (none, natural, electrical) and defrost method (terminated on time or temperature).

When user select specific application based on their requirements, the controller will load a specific set of parameter values and will hide parameters that are not relevant for the selected application. Adjustment of the set of parameters value will be still possible at any time.

In addition to pre-defined applications, all controller versions have two standard applications, one with full list of parameters and another with simplified list of parameters, that allows the user to make their own customized parameter settings (AP0 and AP5 in case of ERC 211 and AP0 and AP6 in case of ERC 213 / ERC 214).

ERC 211 controller

Table 1: Pre-defined application table of ERC 211 controller

APP	Description	Temp. range	Defrost end	DO1	A11	DI1 ⁽¹⁾
AP0	Fully Configurable Standard Application (Cooling / Heating)					
AP1	MT, No defrost	4 – 20 °C	NA		Sair	DI1
AP2	MT, Natural defrost	2 – 6 °C	Time		Sair	DI1
AP3	MT, Natural defrost, defrost stop by Sair	2 – 6 °C	Sair temp		Sair	DI1
AP4	Heating Thermostat	30 – 70 °C	NA		Sair	DI1
AP5	Fully configurable simplified application (Cooling / Heating)					

⁽¹⁾ The digital inputs DI1 can be configured for multiple functions (refer parameter "o02").

ERC 213 controller

Table 2: Pre-defined application table of ERC 213 controller

APP	Description	Temp. range	Defrost end	DO1	DO2	DO3	A11	A12	DI1 ⁽¹⁾	DI2 ⁽¹⁾
AP0	Fully Configurable Standard Application (Cooling / Heating)									
AP1	MT, Natural defrost, Alarm, fan	2 – 6 °C	By time				Sair	NC	DI1/Sc	DI2
AP2	MT, Electrical defrost, Fan	0 – 4 °C	By time				Sair	NC	DI1/Sc	DI2
AP3	LT, Electrical defrost, fan	-24 – -18 °C	By time				Sair	NC	DI1/Sc	DI2
AP4	MT, Electrical defrost, Fan	0 – 4 °C	By temp(S5)				Sair	S5	DI1/Sc	DI2
AP5	LT, Electrical defrost, Fan	-26 – -20 °C	By temp(S5)				Sair	S5	DI1/Sc	DI2
AP6	Fully configurable simplified application (Cooling / Heating)									
AP7	Heating Thermostat	30 – 70 °C	NA				Sair	NC	DI1	DI2

⁽¹⁾ The digital inputs DI1 and DI2 can be configured for multiple functions (refer Parameters "o02" and "o37").

NC = Not configured

ERC 214 controller

Table 3: Pre-defined application table of ERC 214 controller

APP	Description	Temp. range	Defrost end	DO1	DO2	DO3	DO4	AI1	AI2	DI1 ⁽¹⁾	DI2 ⁽¹⁾	
AP0	Fully Configurable Standard Application (Cooling / Heating)											
AP1	MT, Natural defrost, Alarm, fan	2 – 6 °C	By time					Sair	NC	DI1/Sc	DI2	
AP2	MT, Electrical defrost, Fan	0 – 4 °C	By time					Sair	NC	DI1/Sc	DI2	
AP3	LT, Electrical defrost, fan	-24 – -18 °C	By time					Sair	NC	DI1/Sc	DI2	
AP4	MT, Electrical defrost, Fan	0 – 4 °C	By temp(S5)					Sair	S5	DI1/Sc	DI2	
AP5	LT, Electrical defrost, Fan	-26 – -20 °C	By temp(S5)					Sair	S5	DI1/Sc	DI2	
AP6	Fully configurable simplified application (Cooling / Heating)											
AP7	Heating Thermostat	30 – 70 °C	NA					Sair	NC	DI1	DI2	

⁽¹⁾ The digital inputs DI1 and DI2 can be configured for multiple functions (refer Parameters "o02" and "o37")

NC = Not configured

Electrical connection diagram

Table 4: Electrical connection diagram

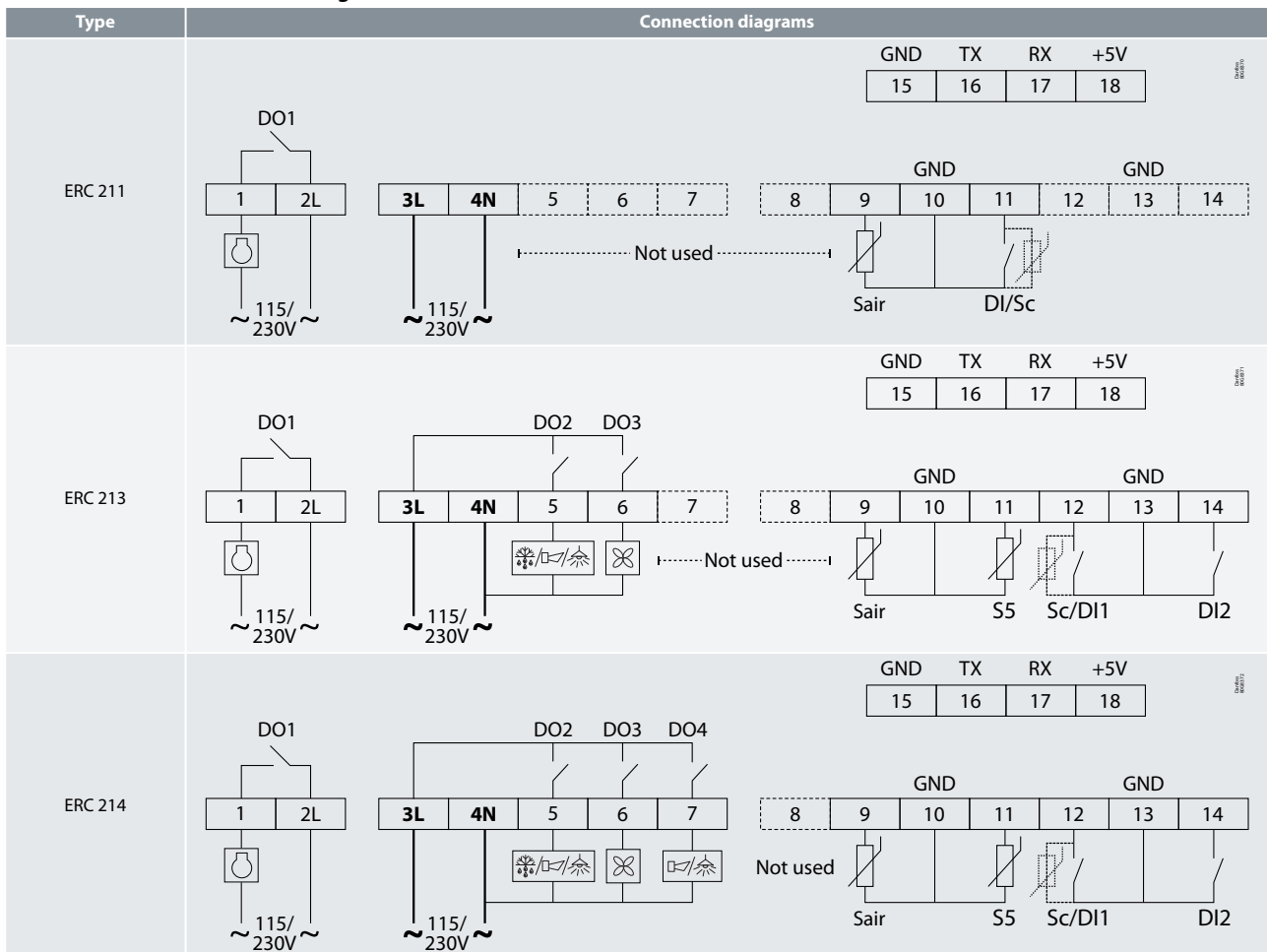

Electronic refrigeration control, type ERC 21X

3L, 4N	Power supply 115 V AC or 230 V AC (refer to the controller label).
Sair	Control Sensor
S5	Defrost (evaporator) sensor
Sc	Condenser sensor
DI1	Digital input - configurable to the functions listed under menu code o02.
DI2	Digital input - configurable to the functions listed under menu code o37.

NOTE:

1. Cables for sensors, DI inputs and data communication must be kept separate from other high voltage cables to avoid electric noises.
 - Use separate cable trays
 - Keep a distance between cables of at least 10 cm
 - Long cables at the DI input should be avoided
2. Do not use excessive force while securing wires in to the connectors, allowed tightening torque and wire sizes are:
 - Power connectors: wire size = 0.5 – 1.5 mm², max. tightening torque = 0.4 Nm
 - Low voltage signal connectors: wire size = 0.15 – 1.5 mm², max. tightening torque = 0.2 Nm
 - 2L and 3L must be connected to the same phase

Configuration

Menu navigation and overview

Table 5: Key functions

	Scroll up: Short press (less than 1 second) Main switch ON/OFF : Press and hold (~ 3 seconds) Factory reset: Press and hold at Power up		Scroll down: Short press (Less than 1 sec.) Defrost Start/Stop : Press and hold (~3 secs.)
	Back function : Short press (less than 1 sec.) Pull down start / stop : Press and hold (~3 secs.)		Set point change or OK : Short press (Less than 1 sec.) Enter Menu : Press and hold (~ 3 secs.)

Table 6: Display icons

	Night mode (Energy saving)		Fan running
	Compressor running (Flashes in pull-down mode)		Active alarm
	Defrost		Unit (°C or °F)

Quick configuration at power up

- **STEP 1: power on**
- **STEP 2: select the quick configuration menu**
Within 30 seconds of power on, press “<” BACK for 3 seconds. The main switch “r12” is automatically set to OFF.
- **STEP 3: select pre-installed application o61**
The display automatically shows the application selection parameter “o61”.
Press SET to select the pre-installed application.
The display shows the default value (eg. “AP0” flashing).
Choose the application type by pressing UP/DOWN and press SET to confirm.
The controller presets parameter values according to the selected application and does not hide relevant parameters.
Tip: you can easily move from AP0 to AP6, and thus select the simplified list of parameters, by pressing the UP key (circular list).
- **STEP 4: select sensor type “o06”**
The display automatically shows sensor selection parameter “o06”.
Press SET to select the sensor type.
The display shows the default value (eg. “n10” flashing).
Choose sensor type by pressing UP/DOWN (n5=NTC 5 K, n10=NTC 10 K, Ptc=PTC, Pt1=Pt1000) and press SET to confirm.
- **NOTE:**
All sensors must be the same type.
- **STEP 5: configure DO4 output “o36”**
The display automatically shows the o36 parameter to configure “DO4” output. (Available only in 4 relays model).
Select light “Lig” or alarm “ALA” as per the application and press SET to confirm.
The display returns to normal display mode and the control is started.

NOTE:

Refer [Pre-defined applications](#) for a complete description of the available applications.

Figure 10: Configuration

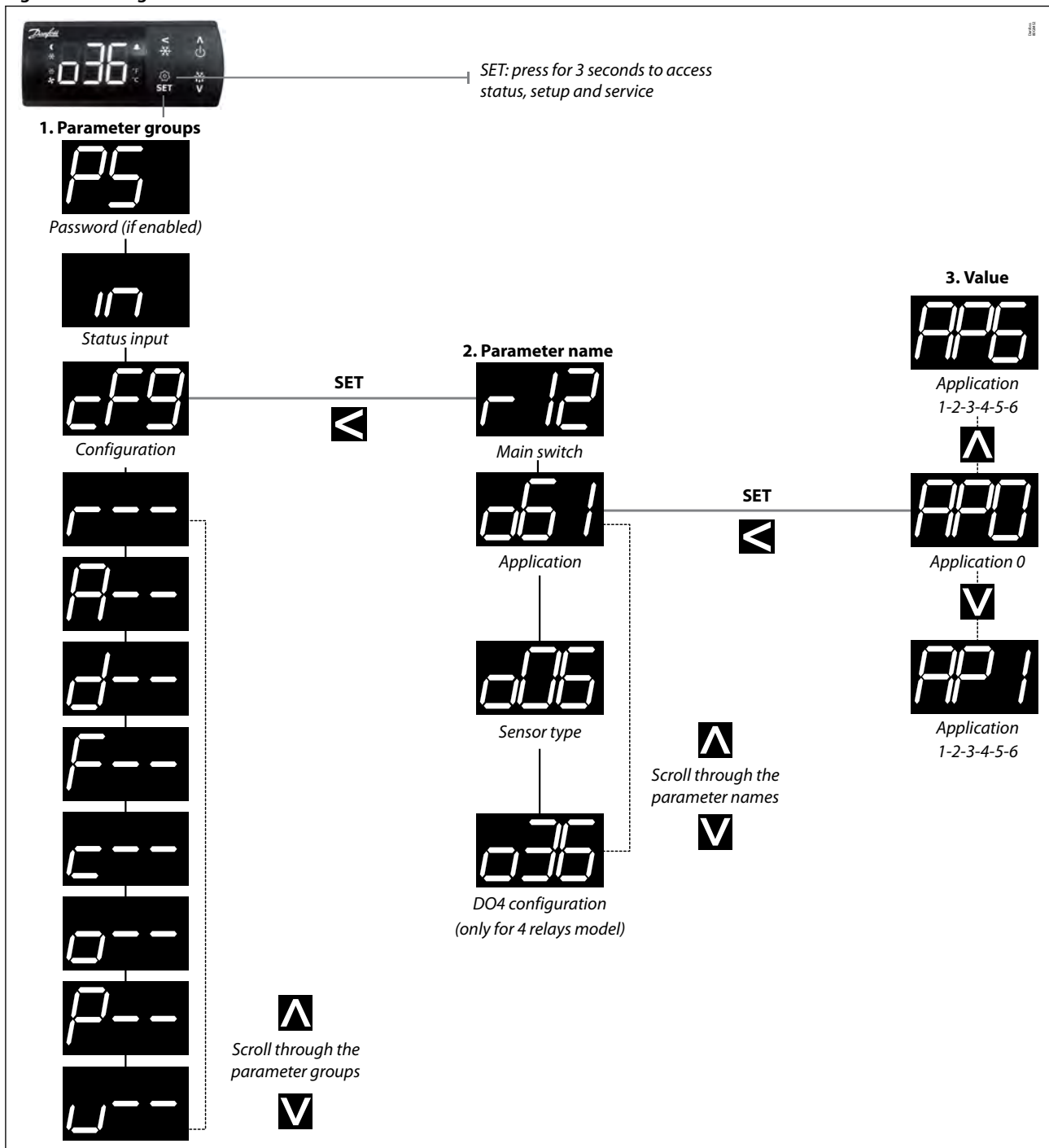

Quick configuration via cFg menu

1. Press "SET" button for 3 seconds to access the parameter menu (display will show "cFg").
2. Enter "cFg" menu by pressing "SET" button (display will show first parameter "r12" main switch).
3. Select "r12" by pressing "SET" button again and set the main switch to "oFF" (r12=0).
4. Press back button (<) to come back to 'cFg' menu.
5. Press DOWN button to scroll through the "cFg" menu parameter list.
6. Open the "o61 application mode" and select needed application mode (Press SET).
7. Open the "o06 Sensor type" and select the temperature sensor type used (n5=NTC 5 K, n10=NTC 10 K, Ptc=PTC, Pt1=Pt1000)- (Press "SET").
8. Open the "o02 DI1 Configuration" and select the function associated to digital input 1 (Press "SET").

9. Open the “o37 DI2 Configuration” and select the function associated to digital input 2 (Press “SET”).
10. Navigate back to parameter “r12 Main switch” and set it in “ON” position to start control.
11. Go through other parameters default settings and change wherever needed

Figure 11: Adjust Setpoint



- | | |
|---|-------------------------------------------------|
| A | Short press "SET" button (Setpoint flashes) |
| B | Press UP/DOWN button to change setpoint |
| C | Press "SET" button to save the changed setpoint |

Figure 12: Initiate a manual defrost



- | | |
|---|-------------------------------------------------------------------------------------------------|
| A | Press "DEFROST" button for 3 seconds to initiate a defrost (Display shows "-d-" during defrost) |
| B | Press "DEFROST" button again for 3 seconds to stop defrost. |

Figure 13: Initiate a pull down



- | | |
|---|-----------------------------------------------------------------------------------------------------------|
| A | Press "PULL DOWN" button for 3 seconds to initiate pull down (controller displays "Pud" during pull down) |
| B | Press "PULL DOWN" button again for 3 seconds to stop the pull down |

Figure 14: View active alarm



- | | |
|---|-----------------------------------------------------------------------------------------------------|
| A | Temperature and alarm codes alternate flashes until the alarm is resolved. The alarm bell is shown. |
|---|-----------------------------------------------------------------------------------------------------|

Figure 15: Unlock keyboard



- A**
- After 5 minutes of no activity, the keypad is locked (if P76=yes).
 - When the keypad is locked any button press shows “LoC” in the display.
 - Press UP and DOWN buttons simultaneously for 3 seconds to unlock the keyboard. “unl” is displayed for 3 seconds.

Factory resetting

The controller can be set back to factory settings by using the following procedure:

1. Power OFF controller.
2. Keep up “^” and down “v” arrow buttons pressed while reconnecting the supply voltage.
3. When the code “Fac” is shown in the display, select “yes”.

i NOTE:

The OEM factory setting will either be the Danfoss factory settings or a user defined factory setting if one has been made. The user can save his setting as OEM factory setting via parameter o67.

Display codes

Table 7: Display codes

Code	Description
-d-	Defrost cycle is in progress
Pud	A temperature pulldown cycle has been initiated
Err	The temperature cannot be displayed due to a sensor error
---	Shown in top of display: The parameter value has reached max. Limit
---	Shown in bottom of display: The parameter value has reached min. Limit
Loc	The display keyboard is locked
UnL	The display keyboard has been unlocked
PS	The access code is required to enter the parameter menu
Axx/Exx	Alarm or error code flashing with normal temp. readout
OFF	Control is stopped as r12 Main switch is set OFF
On	Control is started as r12 Main switch is set ON (code shown in 3 seconds)
Fac	The controller is reset to factory setting

Parameters

Parameter description

Configuration

Table 8: Configuration

Code	Parameter description	Min.	Max.	Unit
cFg	Configuration			
r12	Main Switch With this setting refrigeration can be started, stopped or a manual override of the outputs can be allowed. Service (manual control of outputs allowed)(-1 in Controller Display) OFF (0 in Controller Display) ON (1 in Controller Display)	Service	ON	
o61	Predefined applications Predefined applications is to give the user an easy and fast way to configure the controller. Users can set appropriate application that meets their requirements under this menu (please refer predefined applications table under section 2.4 for more details). Predefined application is protected by main switch.	AP0	AP7	
o07	Select main application type for which controller is used rE= Cooling Ht= Heating	rE	Ht	
o06	Sensor type This parameter defines the type of temperature sensors connected to the controller. Below sensor types can be used in ERC21x n5=NTC 5K (5000 Ohm at 25 °C, Beta value=3980 @25/100 °C) n10= NTC 10 (10000 Ohm at 25 °C, Beta value = 3435 @ 25/100 °C) pt1= PT1000 ptc= PTC All the mounted sensors (Sair, S5 and Sc) must be of same type.	n10	pt1	
o71	This parameter defines the desired configuration for Relay 2 (DO2) dEF=Defrost ALA=alarm Lig=Light	dEF	Lig	
o36	This parameter defines the desired configuration for Relay 4 (DO4). Applicable only for ERC214. Lig=Light ALA=alarm	Lig	ALA	

Thermostat

Table 9: Thermostat

Code	Parameter description	Min.	Max.	Unit
r--	Thermostat			
r00	SetPoint This parameter defines the desired cabinet temperature at which compressor cuts out. The set point can be locked to a range within r02 and r03 settings.	-100.0	200.0	°C
r01	Differential This defines the difference between the cut-out and the cut-in of compressor relay. Compressor relay will cut-in when the cabinet temperature reaches the set point+ differential. In case of heating application, heater will cut-in when the temperature reaches the set point-differential.	0.1	20.0	K
r02	Maximum Set Point limitation The maximum allowable setpoint value can be configured here that would avoid setting too high values by mistake.	-100.0	200.0	°C
r03	Minimum Set Point limitation The minimum allowable setpoint value can be configured here that would avoid setting too low values by accident/mistake.	-100.0	200.0	°C
r04	Display offset Correction value in display temperature. If the temperature of the products / cabinet and the temperature received by the controller are not identical, an offset adjustment of the display temperature can be carried out using this parameter.	-10.0	10.0	K
r05	Display Unit Set here if the controller is to show temperature values in °C or in °F. Switching from one to the other will cause all temperature settings to be automatically updated to respective unit.	-C	-F	
r09	Calibration of Sair This parameter is a relative value and allows adjustment of the Sair sensor temperature. For instance, at a measured temperature of 7 °C and r09 set to 2K, the input from the Sair sensor will be 9 °C instead.	-20.0	20.0	K
r12	Main Switch With this setting refrigeration can be started, stopped or a manual override of the outputs can be allowed. Stopped refrigeration will give a "OFF" signal on the display. -1=service (manual control of outputs allowed) 0=OFF 1=ON	-1	1	
r13	Night setback value The thermostat's reference can be offset by this value during night or when there is no usage. Offset can be set both positive and negative sides (Select a negative value if there is to be cold accumulation). Activation can take place via digital input.	-50.0	50.0	K

Electronic refrigeration control, type ERC 21X

Code	Parameter description	Min.	Max.	Unit
r40	Reference displacement offset temperature The thermostat setpoint and the alarm values get shifted by this value when the reference displacement is activated. Activation can take place via digital input.	-50.0	20.0	°C
r96	Pull-down duration Maximum duration of the pull-down mode. When set as "0" Pull down mode disabled.	0	960	min
r97	Pull-down limit temperature A safety feature; the lowest temperature allowed during pull-down.	-100.0	200.0	°C

Alarm settings

Table 10: Alarm settings

Code	Parameter description	Min.	Max.	Unit
A--	Alarm settings			
A03	Delay for temperature alarm during normal conditions High and low temperature alarm will be delayed by this value after crossing the set alarm limits. The alarm will not become active until the set time delay has been passed.	0	240	min
A12	Delay for temperature alarm during pull-down/start-up/defrost Controller uses this time delay to trigger low and high temperature alarms during start-up, defrost and pull-down modes	0	240	min
A13	High temperature alarm limit If the cabinet temperature stays above this limit for the time mentioned by the alarm delay parameters, high temperature alarm is raised.	-100.0	200.0	°C
A14	Low temperature alarm limit If the cabinet temperature stays below this limit for the time mentioned by the alarm delay parameters, low temperature alarm is raised.	-100.0	200.0	°C
A27	DI1 delay If Di1 is configured as a door open alarm or as an external alarm, this delay is used to raise the respective alarm.	0	240	min
A28	DI2 delay If Di2 is configured as a door open alarm or as an external alarm, this delay is used to raise the respective alarm.	0	240	min
A37	Condenser high alarm limit If the condenser temperature reaches above this limit, condenser alarm is raised immediately and no action is taken. The alarm is reset if temperature falls 5 K below the set temperature.	0	200	°C
A54	Condenser High block limit If the condenser temperature continues to increase above the A37 limit and reaches this temperature limit, condenser block alarm is raised and compressor is stopped. It is restricted to starting again until alarm is reset manually. Manual reset of condenser block alarm can be performed by power cycling the controller either by main switch button or input supply.	0	200	°C
A72	Voltage protection This parameter is to enable and disable the voltage protection feature, which protects compressor from adverse line voltage conditions.	no	YES	
A73	Minimum cut-in voltage When the compressor is due to start, the voltage of the power supply will be checked and the compressor is allowed to start if the supply voltage is greater than this value.	0	270	V
A74	Minimum cut-out voltage When the compressor is running, it will be switched OFF if the supply voltage goes below this value.	0	270	V
A75	Maximum voltage When the compressor is running, it will be switched OFF if the supply voltage exceeds this value.	0	270	V

Defrost

Table 11: Defrost

Code	Parameter description	Min.	Max.	Unit
d--	Defrost			
d01	Defrost type Selection of desired defrost type no= No defrost (defrost function disabled) nAt = Natural defrost (Off cycle defrost) EL = Electrical defrost gAS = Hot gas defrost	no	gAS	
d02	Defrost stop temperature This parameter defines at what temperature the defrost cycle will stop. Defrost can be stopped based on either evaporator sensor or by the cabinet temperature sensor as defined in menu code d10.	0.0	50.0	°C
d03	Defrost interval Defines the maximum time period between the start of two defrost cycles. In case of power failure elapsed time is stored in the memory and next defrost will happen considering the stored time interval.	0	240	hour
d04	Maximum defrost time This parameter defines the maximum time defrost will be performed. In case of temperature based defrost this is treated as safety time to stop the defrost if it is not terminated based on the temperature.	0	480	min
d05	Defrost delay at power up or DI signal This parameter decides the time offset when the defrost is triggered by digital inputs or during power up. This function is only relevant if you have several refrigeration appliances or groups where you want the defrost to be staggered in relation to one another.	0	240	min

Electronic refrigeration control, type ERC 21X

Code	Parameter description	Min.	Max.	Unit
d06	Drip-off time This parameter defines the time delay to start the compressor after defrost heater being switched OFF. This delay is generally provided to ensure all water droplets on the evaporator drips off before starting the refrigeration cycle.	0	60	min
d07	Fan delay after defrost Defines how long the delay is between the start of the compressor and the fan after defrost cycle. This would help to avoid hot air circulation in the cabinet immediately after defrost.	0	60	min
d08	Fan start temperature after defrost This only applies if an evaporator temperature sensor is fitted. This parameter determines at what evaporator temperature the fan will start after a defrost cycle is complete. If the time set in d07 occurs before the temperature set in d08, the fan will start in line with d07. If the temperature set in d08 occurs first, then the fan will start in line with d08.	-50.0	50.0	°C
d09	Fan during defrost This parameter is to define whether fan is to operate during defrost or not.	OFF	on	
d10	Defrost Stop Sensor This parameter is to define which sensor has to be used to exit / terminate the defrost non = none, defrost is based on time Air = Sair sensor dEF = S5 defrost sensor	non	dEF	
d18	Compressor accumulated runtime to start defrost When the accumulated compressor runtime is equal to the value set in this Parameter, defrost will be triggered. If the accumulated compressor runtime is less than the set value during the defined defrost interval (d03), defrost will be triggered based on the defrost interval (d03). This feature is disabled when this parameter is set to zero.	0	96	hour
d19	Defrost on demand The controller will record S5 temperature during each defrost interval when the evaporator is clean and continue to monitor S5 temperature. Controller triggers defrost if the S5 temperature becomes less than recorded temperature by this value it will initiate the defrost on demand. This feature is disabled when this parameter is set to 20. This function can only be used in 1:1 systems.	0.0	20.0	K
d30	Defrost delay after pull down This parameter defines the time delay to start the defrost after pull down cycle. This has to ensure defrost does not happen immediately after pull down cycle.	0	960	min

Fan

Table 12: Fan

Code	Parameter description	Min.	Max.	Unit
F--	Fan			
F01	Fan control during compressor off cycle This parameter define the fan operation during compressor off cycle. FAo=Fan always ON FFC=Fan follow compressor (Fan is switched off during compressor off cycle) FPL= Fan Cycling	FAo	FPL	
F04	Fan stop evaporating temperature This parameter defines the maximum evaporator temperature at which the Fan must switch OFF. If the defrost sensor registers a higher temperature than the one set here, the fans will be stopped to avoid the warm air circulation in the cabinet.	-50.0	50.0	°C
F07	Fan On cycle This parameter is applicable only when the Fan at Compressor cut out (F01) is set to Fan cycling mode. The Fan ON time will be as per the time set in this parameter.	0	180	min
F08	Fan OFF cycle This parameter is applicable only when the Fan at Compressor cut out (F01) is set to Fan cycling mode. The Fan OFF time will be as per the time set in this parameter.	0	180	min

Compressor

Table 13: Compressor

Code	Parameter description	Min.	Max.	Unit
c--	Compressor			
C01	Compressor minimum ON time This parameter determines the minimum number of minutes the compressor must run before a cut-out can take effect based on temperature. This is to avoid sudden switching ON and OFF of the compressor. When used for Heating application, suggest to set this value 0 to avoid any overheating.	0	30	min
C02	Compressor minimum OFF time This parameter determines the minimum number of minutes the compressor must switched OFF before a cut-in can take effect based on temperature. This is to avoid sudden switching OFF and ON of the compressor.	0	30	min
C04	Compressor OFF delay at door open This parameter sets the delay to stop the compressor when the door is opened. If set to 900, the function is disabled.	0	900	sec
C70	Zero crossing selection This feature will increase the relay life time, reduce the contact welding and switching noise by switching ON at Zero crossing. Disable zero crossing when external relay is used.	no	YES	

Miscellaneous

Table 14: Miscellaneous

Code	Parameter description	Min.	Max.	Unit
o--				
o01	Delay of outputs at startup After start-up the controller functions can be delayed by the time delay defined here so that overloading of the electricity supply network is avoided.	0	600	sec
o02	Desired configuration for digital input 1 (DI1) nC= Not configured Sdc = Status display output doo = Door alarm with resumption doA = Door alarm without resumption SCH = Main switch nig = Day/Night mode rFd = Reference displacement EAL = External alarm dEF = Defrost Pud = Pull down Sc = Condensor Sensor	nC	Sc	
o03	Serial Address Data communication is possible by using external TTL to RS485 converter	0	247	No
o05	Password If the settings in the controller are to be protected with an access code you can set a numerical value between 0 and 999. You can cancel the function by setting to 0.	0	999	No
o15	Display Resolution This parameter defines the steps in which the temperature must be displayed by 0.1 or 0.5 or 1	0.1	1.0	
o37	Desired configuration for digital input 2 (DI2) nC= Not configured Sdc = Status display output doo = Door alarm with resumption doA = Door alarm without resumption SCH = Main switch, nig = Day/ Night mode rFd = Reference displacement EAL = External alarm dEF = Defrost Pud = Pull down	nC	Pud	
o38	This defines the method to control cabinet light on= Always on dAn = Day/Night doo=Based on door action	on	doo	
o67	Save settings as factory This parameter when set to YES, The current controller Parameter settings are stored as Factory default. ⚠ WARNING: Original factory settings are overwritten	no	YES	
o91	Display during defrost You can set what is to be displayed during defrost here. Air = actual air temperature FrE = freezed temperature (display the temperature just before starting defrost) -d- = -d- is displayed	Air	-d-	
P--				
P73	DI1 input polarity no (normally open) = associated functionality is activated when DI1 port is short circuit and deactivated when DI1 port is open circuit. nc (normally closed) = associated functionality is activated when DI1 port is open circuit and deactivated when DI1 port is short circuit.	no	nc	
P74	DI2 input polarity no (normally open) = associated functionality is activated when DI2 port is short circuit and deactivated when DI2 port is open circuit. nc (normally closed) = associated functionality is activated when DI2 port is open circuit and deactivated when DI2 port is short circuit.	no	nc	
P75	Invert alarm relay Alarm relay operation can be inverted here 0=normal, 1= invert relay action	0	1	
P76	Key board lock enable Setting this parameter as "YES" enables controller keypad lock functionality after 5 minutes of no activity on the keypad. When the keypad is locked any button press shows "LoC" in the display. Press UP and DOWN buttons simultaneously for 3 seconds to unlock the keyboard. "unl" is displayed for 3 seconds.	no	YES	

Service

Table 15: Service

Code	Parameter description	Min.	Max.	Unit
u--	Service			
u00	Controller Status S0=Cooling ON/Heating ON S2=wait for compressor ON time to elapse S3=wait for compressor OFF time to elapse S4=drip OFF delay after defrost S10=cooling stopped by MainSwitch OFF S11=cooling stopped by thermostat/heating OFF S14=defrosting state S15=fan delay state after defrost S17=door open (DI input) S20=emergency cooling S25=manual control of outputs S30=Pull-down S32=delay of outputs at power up			
u01	Temperature measured by Sair sensor			
u02	Reference set point used for the control			
u09	Temperature measured by evaporator sensor			
u10	Status of connected Digital input configured to DI1 Open Close			
u13	Shows status of night mode ON or OFF			
u37	Status of connected Digital input configured to DI2 Open Close			
u29	Temperature measured by condenser Sensor			
u58	Status of compressor relay ON/OFF			
u59	Status of Fan relay ON/OFF			
u60	Status of Defrost relay ON/OFF			
u63	Status of Light relay ON/OFF			
o23	Relay 1 counter The number of cycles for the DO1 relay can be read in this menu. The read value is multiplied by 100 to obtain the number of cycles. On reaching 999x100 cycles the counts stops and is reset to 0.	0	999	
o24	Relay 2 counter The number of cycles for the DO2 relay can be read in this menu. The read value is multiplied by 100 to obtain the number of cycles. On reaching 999x100 cycles the counts stops and is reset to 0.	0	999	
o25	Relay 3 counter The number of cycles for the DO3 relay can be read in this menu. The read value is multiplied by 100 to obtain the number of cycles. On reaching 999x100 cycles the counts stops and is reset to 0.	0	999	
o26	Relay 4 counter The number of cycles for the DO4 relay can be read in this menu. The read value is multiplied by 100 to obtain the number of cycles. On reaching 999x100 cycles the counts stops and is reset to 0."	0	999	
u80	Firmware version readout			
u82	Controller code number			

Parameters: ERC 211

Configuration

Table 16: Configuration

Function	Code	Min.	Max.	Unit	AP0	AP1	AP2	AP3	AP4	AP5
Configuration	cFg									
Main switch -1=Service, 0=OFF, 1=ON)	r12	-1	1		1	1	1	1	1	1
Predefined applications	o61 ⁽²⁾	AP0	AP5		AP0	AP1	AP2	AP3	AP4	AP5
Cooling/Heating (rE=Cooling, Ht= Heating)	o07 ⁽²⁾	rE	Ht		rE	rE ⁽¹⁾	rE ⁽¹⁾	rE ⁽¹⁾	Ht ⁽¹⁾	rE
Sensor type selection (n5=NTC 5K, n10=NTC10K, ptc=PTC, pt1=PT1000)	o06 ⁽²⁾	n5	ptc		n10	n10	n10	n10	n10	n10

Electronic refrigeration control, type ERC 21X

⁽¹⁾ This option is a default setting in the controller and cannot be changed.

⁽²⁾ This parameter can only be set when regulation is stopped, i.e. "r12" is set to 0.

Reference

Table 17: Reference

Function	Code	Min.	Max.	Unit	AP0	AP1	AP2	AP3	AP4	AP5
Reference	r--									
Setpoint	r00	-100.0	200.0	°C	2.0	8.0	4.0	4.0	50.0	2.0
Differential	r01	0.1	20.0	K	2.0	2.0	2.0	2.0	2.0	2.0
Maximum set point limitation	r02	-100.0	200.0	°C	50.0	20.0	6.0	6.0	70.0	50.0
Minimum set point limitation	r03	-100.0	200.0	°C	-35.0	4.0	2.0	2.0	30.0	-35.0
Display offset	r04	-10.0	10.0	K	0.0	0.0	0.0	0.0	0.0	0.0
Display Unit (°C/ °F)	r05	-C	-F		-C	-C	-C	-C	-C	-C
Calibration of Sair	r09	-20.0	20.0	K	0.0	0.0	0.0	0.0	0.0	-
Main switch (-1=Service, 0=OFF, 1=ON)	r12	-1	1		1	1	1	1	1	1
Night Set back	r13	-50.0	50.0	K	0.0	0.0	0.0	0.0	0.0	0.0
Reference displacement offset temperature	r40	-50.0	20.0	°C	0.0	0.0	0.0	0.0	0.0	-
Pull down duration	r96	0	960	min	0	-	0	0	-	-
Pull down limit temperature	r97	-100.0	200.0	°C	0.0	-	0.0	0.0	-	-

Alarm

Table 18: Alarm

Function	Code	Min.	Max.	Unit	AP0	AP1	AP2	AP3	AP4	AP5
Alarm	A--									
Delay for temp alarm during normal conditions	A03	0	240	min	30	45	45	45	10	30
Delay for temp alarm during pull-down/start up/ defrost	A12	0	240	min	60	60	90	90	NA	60
High temp. alarm limit	A13	-100.0	200.0	°C	8.0	16.0	10.0	10.0	80.0	8.0
Low temp. alarm limit	A14	-100.0	200.0	°C	-30.0	0.0	0.0	0.0	10.0	-30.0
DI1 delay (Time delay for selected DI1 function)	A27	0	240	min	30	30	30	30	30	30
Condenser High alarm limit	A37	0	200	°C	80	80	80	80	-	-
Condenser High block limit	A54	0	200	°C	85	85	85	85	-	-
Voltage protection enable	A72	no	YES		no	no	no	no	no	no
Minimum cut-in voltage	A73	0	270	V	0	0	0	0	0	0
Minimum cut-out voltage	A74	0	270	V	0	0	0	0	0	0
Maximum voltage	A75	0	270	V	270	270	270	270	270	270

Defrost

Table 19: Defrost

Function	Code	Min.	Max.	Unit	AP0	AP1	AP2	AP3	AP4	AP5
Defrost	d--									
Defrost Method (no=no defrost, nAt=Natural)	d01	no	nAt		nAt	no	nAt	nAt	no	no
Defrost stop temperature.	d02	0.0	50.0	°C	6.0	-	-	8.0	-	6.0
Defrost Interval	d03	0	240	hour	8.0	-	6.0	6.0	-	8.0
Max defrost Time	d04	0	480	min	30	-	45	60	-	30
Defrost delay at power up (or DI signal)	d05	0	240	min	0	-	0	0	-	-
Drip delay	d06	0	60	min	0	-	0	0	-	-
Defrost stop sensor non=None (Time), Air = Sair temp. Sensor	d10	non	Air		non	-	non ⁽¹⁾	Air ⁽¹⁾	-	non
Accumulated Compressor runtime to start defrost (0=OFF)	d18	0	96	hour	0	-	0	0	-	-
Defrost delay after pull down cycle	d30	0	960	min	0	-	0	0	-	-

⁽¹⁾ This option is a default setting in the controller and cannot be changed.

Compressor

Table 20: Compressor

Function	Code	Min.	Max.	Unit	AP0	AP1	AP2	AP3	AP4	AP5
Compressor	c--									
Compressor minimum ON time	C01	0	30	min	0.0	0.0	0.0	0.0	0.0	0.0
Compressor minimum OFF time	C02	0	30	min	2.0	2.0	2.0	2.0	2.0	2.0
Compressor OFF delay at open door	C04	0	900	sec	900.0	900.0	900.0	900.0	900.0	60.0
Zero crossing selection (YES / no)	C70	no	YES		YES	YES	YES	YES	YES	YES ⁽¹⁾

⁽¹⁾ This option is a default setting in the controller and cannot be changed.

Others

Function	Code	Min.	Max.	Unit	AP0	AP1	AP2	AP3	AP4	AP5
Others	o--									
Delay of outputs at startup	o01	0	600	sec	10	10	10	10	10	10 ⁽¹⁾
DI1 configuration nC= Not configured; Sdc = Status display output, doo = Door alarm with resumption, doA = Door alarm without resumption, SCH = Main switch, nig = Day/ Night mode, rFd = Reference displacement, EAL = External alarm, dEF = Defrost, Pud = Pull down; Sc = Condensor Sensor	o02	oFF	Sc		oFF	oFF	oFF	oFF	oFF	oFF
Serial address	o03	0	247	No	0	0	0	0	0	-
Password	o05	0	999	No	0	0	0	0	0	0
Sensor type selection (n5=NTC 5K, n10=NTC10K, ptc=PTC, pt1=PT1000)	o06 ⁽²⁾	n5	ptc		n10	n10	n10	n10	n10	n10
Cooling/Heating (rE=Cooling, Ht= Heating)	o07 ⁽²⁾	rE	Ht		rE	rE ⁽¹⁾	rE ⁽¹⁾	rE ⁽¹⁾	Ht ⁽¹⁾	rE
Display Resolution	o15	0.1	1.0		0.1	0.1	0.1	0.1	0.1	0.1 ⁽¹⁾
Predefined applications	o61 ⁽²⁾	AP0	AP5		AP0	AP1	AP2	AP3	AP4	AP5
Save settings as factory	o67	no	YES		no	no	no	no	no	-
⚠ WARNING: The earlier factory settings are overwritten										
Display during defrost Air=actual air temperature, FrE=freeze temperature, -d="-d-" is displayed	o91	-d-	Air		-d-	-	-d-	-d-	-	-d ⁽¹⁾

⁽¹⁾ This option is a default setting in the controller and cannot be changed.

⁽²⁾ This parameter can only be set when regulation is stopped, i.e. "r12" is set to 0

Polarity

Table 21: Polarity

Function	Code	Min.	Max.	Unit	AP0	AP1	AP2	AP3	AP4	AP5
Polarity	P--									
DI1 input polarity (nc/no) no = normally open nc = normally closed	P73	no	nc		no	no	no	no	no	no
Key board lock (no / yes)(0=no, 1=yes)	P76	no	YES		no	no	no	no	no	-

Parameters: ERC 213

Configuration

Table 22: Configuration

Function	Code	Min.	Max.	Unit	AP0	AP1	AP2	AP3	AP4	AP5	AP6	AP7
Configuration	cFg											
Main switch (-1=Service, 0=OFF, 1=ON)	r12	-1	1		1	1	1	1	1	1	1	1
Predefined applications	o61 ⁽²⁾	AP0	AP7		AP0	AP1	AP2	AP3	AP4	AP5	AP6	AP7

Electronic refrigeration control, type ERC 21X

Function	Code	Min.	Max.	Unit	AP0	AP1	AP2	AP3	AP4	AP5	AP6	AP7
Cooling/Heating (rE=Cooling, Ht= Heating)	o07 ⁽²⁾	rE	Ht		rE	rE ⁽¹⁾	rE ⁽¹⁾	rE ⁽¹⁾	rE ⁽¹⁾	rE ⁽¹⁾	rE	Ht ⁽¹⁾
Sensor type (n5=NTC 5K, n10=NTC10K, ptc=PTC, pt1=PT1000)	o06 ⁽²⁾	n5	ptc		n10	n10	n10	n10	n10	n10	n10	n10
DO2 config (dEF=Defrost; ALA=alarm; Lig=Light)	o71 ⁽²⁾	dEF	Lig		dEF	ALA ⁽¹⁾	dEF ⁽¹⁾	dEF ⁽¹⁾	dEF ⁽¹⁾	dEF ⁽¹⁾	dEF	ALA

⁽¹⁾ This option is a default setting in the controller and cannot be changed.

⁽²⁾ This parameter can only be set when regulation is stopped, i.e. "r12" is set to 0.

Reference

Table 23: Reference

Function	Code	Min.	Max.	Unit	AP0	AP1	AP2	AP3	AP4	AP5	AP6	AP7
Reference	r--											
Setpoint	r00	-100.0	200.0	°C	2.0	4.0	2.0	-20.0	2.0	-24.0	2.0	50.0
Differential	r01	0.1	20.0	K	2.0	2.0	2.0	2.0	2.0	2.0	2.0	4.0
Maximum set point limitation	r02	-100.0	200.0	°C	50.0	6.0	4.0	-18.0	4.0	-20.0	50.0	70.0
Minimum set point limitation	r03	-100.0	200.0	°C	-35.0	2.0	0.0	-24.0	0.0	-26.0	-35.0	30.0
Display offset	r04	-10.0	10.0	K	0.0	0.0	0.0	0.0	0.0	0.0	0.0	0.0
Display Unit (°C/ °F)	r05	-C	-F		-C	-C	-C	-C	-C	-C	-C	-C
Calibration of Sair	r09	-20.0	20.0	K	0.0	0.0	0.0	0.0	0.0	0.0	0.0	0.0
Main switch (-1=Service, 0=OFF, 1=ON,)	r12	-1	1		1	1	1	1	1	1	1	1
Night Set back	r13	-50.0	50.0	K	0.0	0.0	0.0	0.0	0.0	0.0	0.0	0.0
Reference displacement offset temperature	r40	-50.0	20.0	°C	0.0	0.0	0.0	0.0	0.0	0.0	-	0.0
Pull down duration	r96	0	960	min	0	0	0	0	0	0	-	-
Pull down limit temperature	r97	-100.0	200.0	°C	0.0	0.0	0.0	0.0	0.0	0.0	-	-

Alarm

Table 24: Alarm

Function	Code	Min.	Max.	Unit	AP0	AP1	AP2	AP3	AP4	AP5	AP6	AP7
Alarm	A--											
Delay for temp alarm during normal conditions	A03	0	240	min	30	45	30	30	30	30	30	10
Delay for temp alarm during pull-down/start up/ defrost	A12	0	240	min	60	90	60	60	60	60	60	-
High temp. alarm limit	A13	-100.0	200.0	°C	8.0	10.0	8.0	-15.0	8.0	-15.0	8.0	80.0
Low temp. alarm limit	A14	-100.0	200.0	°C	-30.0	0.0	-2.0	-30	-2.0	-30.0	-30.0	20.0
DI1 delay (Time delay for selected DI1 function)	A27	0	240	min	30	30	30	30	30	30	30	30
DI2 delay (Time delay for selected DI2 function)	A28	0	240	min	30	30	30	30	30	30	30	30
Condenser High alarm limit	A37	0	200	°C	80	80	80	80	80	80	-	-
Condenser High block limit	A54	0	200	°C	85	85	85	85	85	85	-	-
Voltage protection enable	A72	no	YES		no	no	no	no	no	no	no	no
Minimum cut-in voltage	A73	0	270	V	0	0	0	0	0	0	0	0
Minimum cut-out voltage	A74	0	270	V	0	0	0	0	0	0	0	0
Maximum voltage	A75	0	270	V	270	270	270	270	270	270	270	270

Defrost

Table 25: Defrost

Function	Code	Min.	Max.	Unit	AP0	AP1	AP2	AP3	AP4	AP5	AP6	AP7
Defrost	d--											
Defrost Method (no=None, nAt=Natural, EL = Electric; gAS=Hot gas)	d01	no	gAS		EL	nAt	EL	EL	EL	EL	EL	-
Defrost stop temperature.	d02	0.0	50.0	°C	6.0	-	-	-	6.0	6.0	6.0	-
Defrost Interval	d03	0	240	hour	8	6	8	12	8	12	8	-
Max defrost Time	d04	0	480	min	30	45	15	15	30	30	30	-
Defrost delay at power up	d05	0	240	min	0	0	0	0	0	0	NA	-
Drip delay	d06	0	60	min	0	0	0	0	0	0	2 ⁽¹⁾	-
Fan delay after defrost	d07	0	60	min	0	0	0	0	0	0	5 ⁽¹⁾	-
Fan start temperature after defrost	d08	-50.0	50.0	°C	-5.0	50.0 ⁽¹⁾	50.0 ⁽¹⁾	50.0 ⁽¹⁾	-5.0	-5.0	-	-

Electronic refrigeration control, type ERC 21X

Function	Code	Min.	Max.	Unit	AP0	AP1	AP2	AP3	AP4	AP5	AP6	AP7
Fan during defrost	d09	OFF	on		on	on	OFF	OFF	OFF	OFF	OFF	-
Defrost stop sensor non=None (Time), Air = Sair temp. sensor, dEF= S5 Defrost sensor	d10	non	dEF		non	non ⁽¹⁾	non ⁽¹⁾	non ⁽¹⁾	dEF ⁽¹⁾	dEF ⁽¹⁾	non	-
Accumulated Compressor runtime to start defrost (0=OFF)	d18	0	96	hour	0	0	0	0	0	0	-	-
Defrost on demand (20=OFF)	d19	0.0	20.0	K	20.0	20.0 ⁽¹⁾	20.0 ⁽¹⁾	20.0 ⁽¹⁾	20.0	20.0	-	-
Defrost delay after pull down cycle	d30	0	960	min	0	0	0	0	0	0	-	-

⁽¹⁾ This option is a default setting in the controller and cannot be changed.

Fan control

Table 26: Fan control

Function	Code	Min.	Max.	Unit	AP0	AP1	AP2	AP3	AP4	AP5	AP6	AP7
Fan control	F--											
Fan at compressor cutout (FAo=Fan always ON; FFC=Fan follow compressor; FPL= Fan Pulsating)	F01	Fao	FPL		FAo	FAo	FAo	FAo	FAo	FAo	FAo	FAo
Fan stop evap. Temperature	F04	-50.0	50.0	°C	50.0	-	-	-	50.0	50.0	50.0	-
Fan ON Cycle	F07	0	180	min	2	2	2	2	2	2 ⁽¹⁾	2	2
Fan OFF cycle	F08	0	180	min	2	2	2	2	2	2 ⁽¹⁾	2	2

⁽¹⁾ This option is a default setting in the controller and cannot be changed.

Compressor

Table 27: Compressor

Function	Code	Min.	Max.	Unit	AP0	AP1	AP2	AP3	AP4	AP5	AP6	AP7
Compressor	c--											
Compressor / Heater minimum ON time	C01	0	30	min	0	0	0	0	0	0	0	0
Compressor /Heater minimum OFF time	C02	0	30	min	2	2	2	2	2	2	2	2
Compressor OFF delay at open door	C04	0	900	Sec	900	900	900	900	900	900	60 ⁽¹⁾	900
Zero crossing selection (YES / no)	C70	no	YES		YES	YES	YES	YES	YES	YES	YES ⁽¹⁾	YES

⁽¹⁾ This option is a default setting in the controller and cannot be changed.

Others

Table 28: Others

Function	Code	Min.	Max.	Unit	AP0	AP1	AP2	AP3	AP4	AP5	AP6	AP7
Others	o--											
Delay of outputs at startup	o01	0	600	sec	10	10	10	10	10	10	10 ⁽¹⁾	10
DI1 configuration nC= Not configured; Sdc = Status display output, doo = Door alarm with resumption, doA = Door alarm without resumption, SCH = Main switch, nig = Day/ Night mode, rFd = Reference displasement, EAL = External alarm, dEF = Defrost, Pud = Pull down; Sc = Condensor Sensor	o02	nC	Sc		nC	nC	nC	nC	nC	nC	nC	nC
Serial address	o03	0	247	No	0	0	0	0	0	0	-	0
Password	o05	0	999	No	0	0	0	0	0	0	0	0
Sensor type (n5=NTC 5K, n10=NTC10K, ptc=PTC, pt1=PT1000)	o06 ⁽²⁾	n5	ptc		n10	n10	n10	n10	n10	n10	n10	n10
Cooling/Heating (rE=Cooling, Ht= Heating)	o07 ⁽²⁾	rE	Ht		rE	rE ⁽¹⁾	rE ⁽¹⁾	rE ⁽¹⁾	rE ⁽¹⁾	rE ⁽¹⁾	rE	Ht ⁽¹⁾
Display Resolution	o15	0.1	1.0		0.1	0.1	0.1	0.1	0.1	0.1	0.1 ⁽¹⁾	0.1
DI2 configuration nC= Not configured; Sdc = Status display output, doo = Door alarm with resumption, doA = Door alarm without resumption, SCH = Main switch, nig = Day/Night mode, rFd = Reference displasement, EAL = External alarm, dEF = Defrost, Pud = Pull down	o37	nC	Pud		nC	nC	nC	nC	nC	nC	nC	nC

Electronic refrigeration control, type ERC 21X

Function	Code	Min.	Max.	Unit	AP0	AP1	AP2	AP3	AP4	AP5	AP6	AP7
Light Control on= Always on, dAn = Day/Night, doo=Based on door action	o38	on	doo		on	on	on	on	on	on	on	on
Predefined applications	o61 ⁽²⁾	AP0	AP7		AP0	AP1	AP2	AP3	AP4	AP5	AP6	AP7
Save settings as factory NOTE: The earlier factory settings are overwritten	o67	no	YES		no	no	no	no	no	no	-	no
DO2 config dEF=Defrost; ALA=alarm; Lig=Light	o71 ⁽²⁾	dEF	Lig		dEF	ALA ⁽¹⁾	dEF ⁽¹⁾	dEF ⁽¹⁾	dEF ⁽¹⁾	dEF ⁽¹⁾	dEF	ALA
Display during defrost Air=actual air temperature, FrE=freeze temperature, -d="-d-" is displayed	o91	Air	-d-		-d-	-d-	-d-	-d-	-d-	-d-	-d ⁽¹⁾	-

⁽¹⁾ This option is a default setting in the controller and cannot be changed.

⁽²⁾ This parameter can only be set when regulation is stopped, i.e. "r12" is set to 0.

Polarity

Table 29: Polarity

Function	Code	Min.	Max.	Unit	AP0	AP1	AP2	AP3	AP4	AP5	AP6	AP7
Polarity	P--											
DI1 input polarity (nc/no) no = normally open nc = normally closed	P73	no	nc		no	no	no	no	no	no	no	no
DI2 input polarity (nc/no) no = normally open nc = normally closed	P74	no	nc		no	no	no	no	no	no	no	no
Invert alarm relay (0= normal, 1= invert relay action)	P75	0	1		0	0	0	0	0	0	-	0
Key board lock (no / yes)(0=no, 1=yes)	P76	no	YES		no	no	no	no	no	no	-	no

Parameters: ERC 214

Configuration

Table 30: Configuration

Function	Code	Min.	Max.	Unit	AP0	AP1	AP2	AP3	AP4	AP5	AP6	AP7
Configuration	cFg											
Main switch (-1=Service, 0=OFF, 1=ON)	r12	-1	1		1	1	1	1	1	1	1	1
Predefined applications	o61 ⁽²⁾	AP0	AP7		AP0	AP1	AP2	AP3	AP4	AP4	AP6	AP7
Cooling/Heating (rE=Cooling, Ht= Heating)	o07 ⁽²⁾	rE	Ht		rE	rE ⁽¹⁾	rE ⁽¹⁾	rE ⁽¹⁾	rE ⁽¹⁾	rE ⁽¹⁾	rE	Ht ⁽¹⁾
Sensor type selection (n5=NTC 5K, n10=NTC10K, ptc=PTC, pt1=PT1000)	o06 ⁽²⁾	n10	pt1		n10	n10	n10	n10	n10	n10	n10	n10
DO2 config (dEF=Defrost; ALA=alarm; Lig=Light)	o71 ⁽²⁾	dEF	Lig		dEF	ALA ⁽¹⁾	dEF ⁽¹⁾	dEF ⁽¹⁾	dEF ⁽¹⁾	dEF ⁽¹⁾	dEF	ALA ⁽¹⁾
DO4 config (Lig=Light, ALA=Alarm)	o36 ⁽²⁾	Lig	ALA		Lig	Lig	Lig	Lig	Lig	Lig	Lig	Lig

⁽¹⁾ This option is a default setting in the controller and cannot be changed.

⁽²⁾ This parameter can only be set when regulation is stopped, i.e. "r12" is set to 0.

Reference

Table 31: Reference

Function	Code	Min.	Max.	Unit	AP0	AP1	AP2	AP3	AP4	AP5	AP6	AP7
Reference	r--											
Setpoint	r00	-100.0	200.0	°C	2.0	4.0	2.0	-20.0	2.0	-24.0	2.0	50.0
Differential	r01	0.1	20.0	K	2.0	2.0	2.0	2.0	2.0	2.0	2.0	4.0
Maximum set point limitation	r02	-100.0	200.0	°C	50.0	6.0	4.0	-18.0	4.0	-20.0	50.0	70.0
Minimum set point limitation	r03	-100.0	200.0	°C	-35.0	2.0	0.0	-24.0	0.0	-26.0	-35.0	30.0
Display offset	r04	-10.0	10.0	K	0.0	0.0	0.0	0.0	0.0	0.0	0.0	0.0
Display Unit (°C/ °F)	r05	-C	-F		-C	-C	-C	-C	-C	-C	-C	-C
Calibration of Sair	r09	-20.0	20.0	K	0.0	0.0	0.0	0.0	0.0	0.0	0.0	0.0

Electronic refrigeration control, type ERC 21X

Function	Code	Min.	Max.	Unit	AP0	AP1	AP2	AP3	AP4	AP5	AP6	AP7
Main switch (-1=Service, 0=OFF, 1=ON,)	r12	-1	1		1	1	1	1	1	1	1	1
Night Set back	r13	-50.0	50.0	K	0.0	0.0	0.0	0.0	0.0	0.0	0.0	0.0
Reference displacement offset temperature	r40	-50.0	20.0	°C	0.0	0.0	0.0	0.0	0.0	0.0	-	0.0
Pull down duration	r96	0	960	min	0	0	0	0	0	0	-	-
Pull down limit temperature	r97	-100.0	200.0	°C	0.0	0.0	0.0	0.0	0.0	0.0	-	-

Alarm

Table 32: Alarm

Function	Code	Min.	Max.	Unit	AP0	AP1	AP2	AP3	AP4	AP5	AP6	AP7
Alarm	A--											
Delay for temp alarm during normal conditions	A03	0	240	min	30	45	30	30	30	30	30	10
Delay for temp alarm during pull-down/start up/ defrost	A12	0	240	min	60	90	60	60	60	60	60	-
High temp. alarm limit	A13	-100.0	200.0	°C	8.0	10.0	8.0	-15.0	8.0	-15.0	8.0	80.0
Low temp. alarm limit	A14	-100.0	200.0	°C	-30.0	0.0	-2.0	-30.0	-2.0	-30.0	-30.0	20.0
DI1 delay (Time delay for selected DI1 function)	A27	0	240	min	30	30	30	30	30	30	30	30
DI2 delay (Time delay for selected DI2 function)	A28	0	240	min	30	30	30	30	30	30	30	30
Condenser High alarm limit	A37	0	200	°C	80	80	80	80	80	80	-	-
Condenser High block limit	A54	0	200	°C	85	85	85	85	85	85	-	-
Voltage protection	A72	no	YES		no	no	no	no	no	no	no	no
Minimum cut-in voltage	A73	0	270	V	0	0	0	0	0	0	0	0
Minimum cut-out voltage	A74	0	270	V	0	0	0	0	0	0	0	0
Maximum voltage	A75	0	270	V	270	270	270	270	270	270	270	270

Defrost

Table 33: Defrost

Function	Code	Min.	Max.	Unit	AP0	AP1	AP2	AP3	AP4	AP5	AP6	AP7
Defrost	d--											
Defrost Method (no=None, nAt=Natural, EL = Electric; gAS=Hot gas)	d01	no	gAS		EL	nAt	EL	EL	EL	EL	EL	-
Defrost stop temperature.	d02	0.0	50.0	°C	6.0	-	-	-	6.0	6.0	6.0	-
Defrost Interval	d03	0	240	hour	8	6	8	12	8	12	8	-
Max defrost Time	d04	0	480	min	30	45	15	15	30	30	30	-
Defrost delay at power up (or DI signal)	d05	0	240	min	0	0	0	0	0	0	-	-
Drip delay	d06	0	60	min	0	0	0	0	0	0	2 ⁽¹⁾	-
Fan delay after defrost	d07	0	60	min	0	0	0	0	0	0	5 ⁽¹⁾	-
Fan start temperature after defrost	d08	-50.0	50.0	°C	-5.0	50.0 ⁽¹⁾	50.0 ⁽¹⁾	50.0 ⁽¹⁾	-5.0	-5.0	NA	-
Fan during defrost	d09	OFF	on		on	on	OFF	OFF	OFF	OFF	OFF	-
Defrost stop sensor	d10	non	dEF		non	non ⁽¹⁾	non ⁽¹⁾	non ⁽¹⁾	dEF ⁽¹⁾	dEF ⁽¹⁾	non	-
Accumulated Compressor runtime to start defrost (0=OFF)	d18	0	96	hour	0	0	0	0	0	0	-	-
Defrost on demand (20=OFF)	d19	0.0	20.0	K	20.0	-	-	-	20.0	20.0	-	-
Defrost delay after pull down cycle	d30	0	960	min	0	0	0	0	0	0	-	-

⁽¹⁾ This option is a default setting in the controller and cannot be changed.

Fan control

Table 34: Fan control

Function	Code	Min.	Max.	Unit	AP0	AP1	AP2	AP3	AP4	AP5	AP6	AP7
Fan control	F--											
Fan at compressor cutout	F01	FAo	FPL		FAo	FAo	FAo	FAo	FAo	FAo	FAo	FAo
Fan stop evap. Temperature	F04	-50.0	50.0	°C	50.0	-	-	-	50.0	50.0	50.0 ⁽¹⁾	-
Fan ON Cycle	F07	0	180	min	2	2	2	2	2	2	2 ⁽¹⁾	2
Fan OFF cycle	F08	0	180	min	2	2	2	2	2	2	2 ⁽¹⁾	2

⁽¹⁾ This option is a default setting in the controller and cannot be changed.

Compressor

Table 35: Compressor

Function	Code	Min.	Max.	Unit	AP0	AP1	AP2	AP3	AP4	AP5	AP6	AP7
Compressor	C--											
Compressor minimum ON time	C01	0	30	min	0	0	0	0	0	0	0	0
Compressor minimum OFF time	C02	0	30	min	2	2	2	2	2	2	2	2
Compressor /Heater OFF delay at open door	C04	0	900	Secs	900	900	900	900	900	900	60 ⁽¹⁾	900
Zero crossing selection (YES / NO)	C70	no	YES		YES	YES	YES	YES	YES	YES	YES ⁽¹⁾	YES

⁽¹⁾ This option is a default setting in the controller and cannot be changed.

Others

Table 36: Others

Function	Code	Min.	Max.	Unit	AP0	AP1	AP2	AP3	AP4	AP5	AP6	AP7
Others	O--											
Delay of outputs at startup	o01	0	600	sec	10	10	10	10	10	10	10 ⁽¹⁾	10
DI1 configuration nC= Not configured; Sdc = Status display output, doo = Door alarm with resumption, doA = Door alarm without resumption, SCH = Main switch, nig = Day/ Night mode, rFd = Reference displacement , EAL = External alarm, dEF = Defrost, Pud = Pull down; Sc = Condensor Sensor	o02	nC	Sc		nC	nC	nC	nC	nC	nC	nC	nC
Serial address	o03	0	247	No	0	0	0	0	0	0	-	0.0
Password	o05	0	999	No	0	0	0	0	0	0	0	0
Sensor type selection (n5=NTC 5K, n10=NTC10K, ptc=PTC, pt1=PT1000)	o06 ⁽²⁾	n10	ptc		n10	n10	n10	n10	n10	n10	n10	n10
Cooling/Heating (rE=Cooling, Ht= Heating)	o07 ⁽²⁾	rE	Ht		rE	rE ⁽¹⁾	rE ⁽¹⁾	rE ⁽¹⁾	rE ⁽¹⁾	rE ⁽¹⁾	rE	Ht ⁽¹⁾
Display Resolution	o15	0.1	1.0		0.1	0.1	0.1	0.1	0.1	0.1	0.1 ⁽¹⁾	0.1
DO4 config (Lig=Light, ALA=Alarm)	o36 ⁽²⁾	Lig	ALA		Lig	Lig	Lig	Lig	Lig	Lig	Lig	Lig
DI2 configuration nC= Not configured; Sdc = Status display output, doo = Door alarm with resumption, doA = Door alarm without resumption, SCH = Main switch, nig = Day/ Night mode, rFd = Reference displacement , EAL = External alarm, dEF = Defrost, Pud = Pull down	o37	nC	Pud		nC	nC	nC	nC	nC	nC	nC	nC
Light Control on= Always on, dAn = Day/Night, doo=Based on door action	o38	on	doo		on	on	on	on	on	on	on	on
Predefined applications	o61 ⁽²⁾	AP0	AP7		AP0	AP1	AP2	AP3	AP4	AP4	AP6	AP7
Save settings as factory	o67	no	YES		no	no	no	no	no	no	-	no
DO2 config (dEF=Defrost; ALA=alarm; Lig=Light)	o71 ⁽²⁾	dEF	Lig		dEF	ALA ⁽¹⁾	dEF ⁽¹⁾	dEF ⁽¹⁾	dEF ⁽¹⁾	dEF ⁽¹⁾	dEF	ALA ⁽¹⁾
Display during defrost	o91	Air	-d-		-d-	-d-	-d-	-d-	-d-	-d-	-d ⁽¹⁾	-

⁽¹⁾ This option is a default setting in the controller and cannot be changed.

⁽²⁾ This parameter can only be set when regulation is stopped, i.e. "r12" is set to 0

Polarity

Table 37: Polarity

Function	Code	Min.	Max.	Unit	AP0	AP1	AP2	AP3	AP4	AP5	AP6	AP7
Polarity	P--											
DI1 input polarity (nc/no) no = normally open nc = normally closed	P73	no	nc		no	no	no	no	no	no	no	no
DI2 input polarity (nc/no) no = normally open nc = normally closed	P74	no	nc		no	no	no	no	no	no	no	no
Invert alarm relay (0= normal, 1= invert relay ac- tion)	P75	0	1		0	0	0	0	0	0	-	0.0
Key board lock (no / yes)(0=no, 1=yes)	P76	no	YES		no	no	no	no	no	no	-	no

Alarm code

In an alarm situation the display will alternate between readout of the actual air temperature and readout of the alarm codes of active alarms. Various alarm codes and their descriptions are as below.

Table 38: Alarm codes

Code	Alarms	Description
E29	Sair sensor error	Air temperature sensor is defect or electrical connection is lost
E27	Def sensor error	SS Evaporator sensor is defect or electrical connection is lost
E30	Sc sensor error	Sc Condenser sensor is defect or electrical connection is lost
A01	High temp alarm	Air temperature in cabinet is too high
A02	Low temp alarm	Air temperature in cabinet is too low
A99	High Volt alarm	Supply voltage is too high (compressor protection)
AA1	Low Volt alarm	Supply voltage is too low (compressor protection)
A61	Condenser alarm	Condenser temp. too high - check air flow
A80	Cond. block alarm	Condenser temp. too high - manual reset of alarm required ⁽¹⁾
A04	Door alarm	Door has been open for too long
A15	DI Alarm	External alarm from DI input
A45	Standby Alarm	Control has been stopped by "r12 Main switch"

⁽¹⁾ The condenser block alarm can be reset by setting r12 Main switch OFF and ON again or by powering down the controller.

Product specification

Technical specification

Table 39: Technical specification

Features	Description
Purpose of control	Operating temperature sensing control suitable for incorporation into commercial air-conditioning and refrigeration applications
Construction of control	Incorporated control
Power supply	115 V AC / 230 V AC 50/60 Hz, galvanic isolated low voltage regulated power supply
Rated power	Less than 0.7 W
Inputs	Sensor inputs, Digital inputs, Programming key Connected to SELV limited energy <15 W
Allowed sensor types	NTC 5000 Ohm at 25 °C, (Beta value=3980 at 25/100 °C - EKS 211) NTC 10000 Ohm at 25 °C, (Beta value=3435 at 25/85 °C - EKS 221) PTC 990 Ohm at 25 °C, (EKS 111) Pt1000, (AKS 11, AKS 12, AKS 21)
Sensors included in kit Solution	NTC 10000 Ohm at 25 °C, cable length: 1.5 m
Accuracy	Measuring range: -40 – 105 °C (-40 – 221 °F) Controller accuracy: ±1 K below -35 °C, ±0.5 K between -35 – 25 °C ±1 K above 25 °C
Type of action	1B (relay)
Output	DO1 - Relay 1: 16 A, 16 (16) A, EN 60730-1 10 FLA / 60 LRA at 230 V, UL60730-1 16 FLA / 72 LRA at 115 V, UL60730-1 DO2 - Relay 2: 8 A, 2 FLA / 12 LRA, UL60730-1 8 A, 2 (2 A), EN60730-1 DO3 - Relay 3: 3 A, 2 FLA / 12 LRA, UL60730-1 3 A, 2 (2 A), EN60730-1 DO4 - Relay 4: 2 A
Display	LED display, 3 digits, decimal point and multi-function icons, °C + °F scale
Operating conditions	-10 – +55 °C (14 – 131 °F), 90% Rh
Storage conditions	-40 – +70 °C (-40 – +158 °F), 90% Rh
Protection	Front: IP65 (Gasket integrated) Rear: IP00
Environmental	Pollution degree II, non-condensing
Overvoltage category	II - 230 V supply version - (ENEC, UL recognized) III - 115 V supply version - (UL recognized)
Resistance to heat and fire	UL94-V0 Temperature for ball pressure test statement According to Annex G (EN 60730-1)
EMC category	Emission: IEC/EN 61000 6-3, Immunity: IEC/EN 61000 6-2

Mounting

Figure 16: Mounting

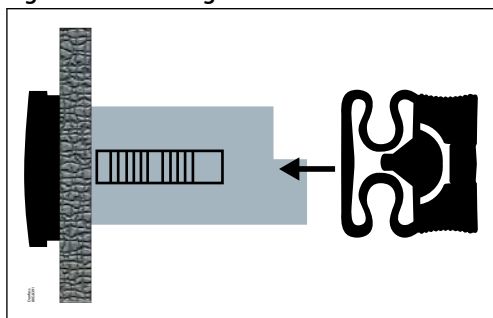
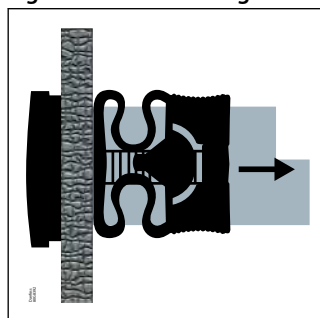

Figure 17: Dismounting



Installation steps

- Place the wired controller in the slot and ensure rubber sealing is resting properly on the mounting surface.
- Slide the mounting clips along the rails of the rear plastic from the rear side of the panel.
- Slide the clips towards mounting surface until controller is firmly fixed.
- To remove the controller, one needs to skillfully unlatch the snapping tab and pull the clips backwards.

Dimensions

Figure 18: Dimensions (mm)

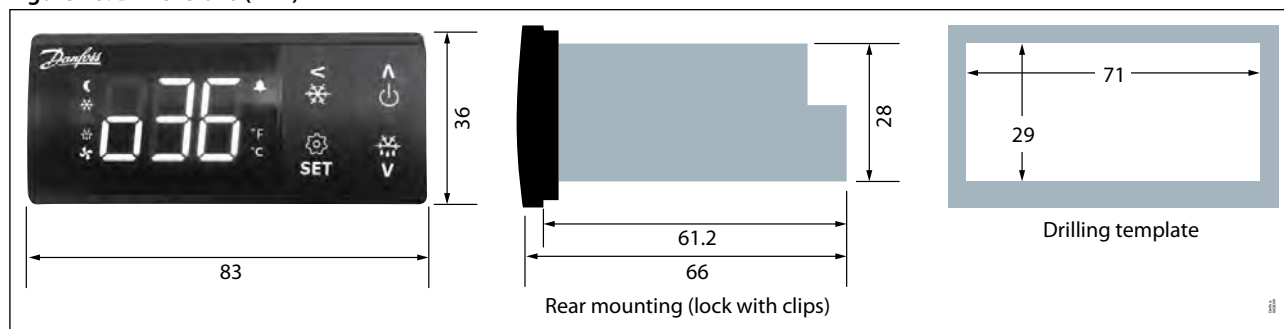

Accessories

KoolKey (EKA200)

KoolKey acts as a gateway to connect PC tool KoolProg and also a programming key.

Figure 19: KoolKey (EKA 200) as gateway

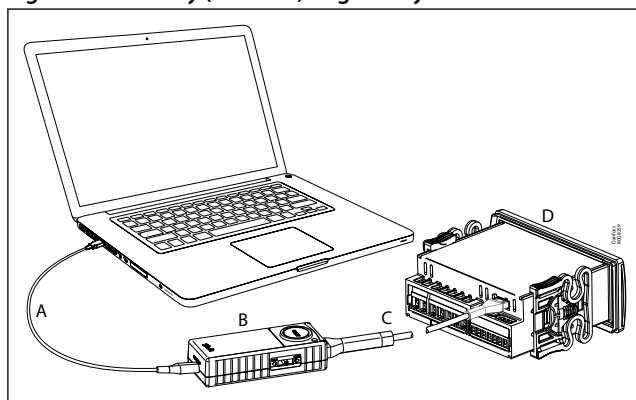

A	Standard Micro-USB cable
B	KoolKey
C	Interface cable
D	Controller

Figure 20: KoolKey (EKA 200) as programming key

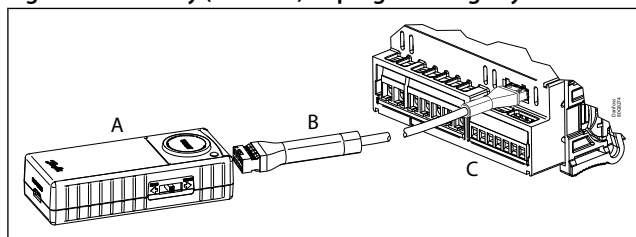

A	Koolkey
B	Interface cable
C	Controller

Refer to the KoolKey [installation guide](#) for detailed instructions.

Mass Programming Key (EKA 201)

Mass Programming Key is a simple programming key for programming the controller in production assembly line.

Figure 21: Mass Programming Key (EKA 201)

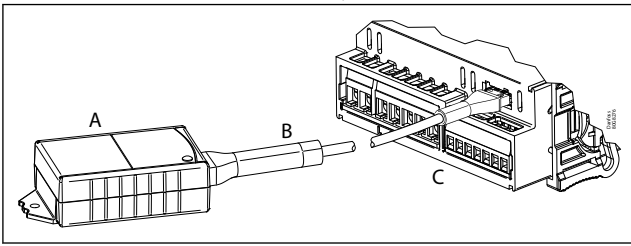

A	EKA 201
B	Interface cable
C	Controller

Refer to the EKA 201 [installation guide](#) for detailed instructions.

Bluetooth Adapter (EKA 202 & EKA 203)

Bluetooth Adapter: external plug-in type module that provides wireless connectivity with Danfoss mobile application "KoolConnect".

Figure 22: Bluetooth Adapter (EKA 202 & EKA 203)

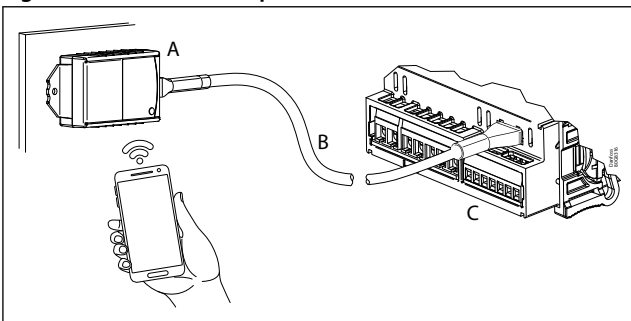

A	Bluetooth adapter
B	Interface cable
C	Controller

Refer to the EKA 202/203 [installation guide](#) for detailed instructions.

Ordering

Table 40: ERC 21X controllers

Type	Description	Relay	Qty.	Code no.
ERC 211	ERC 211, Red LED, 115 V - Kit	1	1	080G3451
	ERC 211, Red LED, 230 V - Kit	1	1	080G3453
	ERC 211, Controller, Red LED, 230 V	1	1	080G3454
	ERC 211, Controller, Red LED, 230 V, I-Pack	1	30	080G3459
ERC 213	ERC 213, Red LED, 230 V - Kit	3	1	080G3457
	ERC 213, Controller, Red LED, 230 V	3	1	080G3458
	ERC 213, Controller, Red LED, 230 V, I-Pack	3	30	080G3460
	ERC 213 Red, 115 V USA - Kit	3	1	080G3467
	ERC 213 Red, 230 V USA - Kit	3	1	080G3469
ERC 214	ERC 214, Controller, Red LED, 115 V, I-Pack	4	30	080G3466
	ERC 214, Controller, Red LED, 230 V, I-Pack	4	30	080G3463

Table 41: Programming tools and other accessories

Type	Description	Qty.	Code no.
EKA 200	KoolKey - Gateway cum Programming key	1	080N0020
EKA 201	Mass Programming Key	1	080N0021
BLE Adapter	Without RTC power back up	Single pack	080N0022
		54	080N0026
	With RTC power back up	Single pack	080N0023
		54	080N0027
Interface cable	Interface cable for ERC 21x, 0.5 m	1	080N0327
	Interface cable for ERC 21x, 1 m	1	080N0328

Table 42: Sensors

Type	Sensor element	Sensor housing	Cable	Qty.	Code no.
EKS 211	NTC 5000 ohm / 25 °C (Beta =3980 at 25/100 °C)	Thermo plastic polyester 8x30	1.5 m	150	084B4403
		Thermo plastic polyester 8x30	3.5 m	75	084B4404
		Thermo plastic polyester 8x30	1.5 m	1	084N1220
		Thermo plastic polyester 8x30	3.5 m	1	084N1221
EKS 221	NTC 10000 ohm / 25 °C (Beta =3435 at 25/85 °C)	Thermo plastic rubber 6x5x15	3.5 m	150	084N3206
		Thermo plastic rubber 6x5x15	3.5 m	1	084N3210
		Thermo plastic rubber 6x5x15	8.5 m	50	084N3208
		Thermo plastic rubber 6x5x15	8.5 m	1	084N3209
		Stainless steel 6x20	1.5 m	150	084N3200
EKS 111	PTC 990 ohm / 25 °C	Stainless steel 6x30	1.5 m	1	084N1178
		Stainless steel 6x30	1.5 m	150	084N1161
		Stainless steel 6x30	3.5 m	1	084N1179
		Stainless steel 6x30	3.5 m	150	084N1163
		Stainless steel 6x30	6 m	1	084N1180
		Stainless steel 6x30	6 m	80	084N1173
		Stainless steel 6x30	8.5 m	60	084N1168
AKS 11	PT1000	Top part: PPO (Noryl) Bottom: stainless steel	3.5 m	1	084N0003
		Top part: PPO (Noryl) Bottom: stainless steel	5.5 m	1	084N0005
		Top part: PPO (Noryl) Bottom: stainless steel	8.5 m	1	084N0008
		Stainless steel 6x40	1.5 m	1	084N0036
AKS 12	PT1000	Stainless steel 6x40	1.5 m	30	084N0035
		Stainless steel 6x40	3.5 m	30	084N0039
		Stainless steel 6x40	5.5 m	30	084N0038

NOTE:

All the mounted sensors must be of same type.

Certificates, declarations, and approvals

The list contains all certificates, declarations, and approvals for this product type. Individual code number may have some or all of these approvals, and certain local approvals may not appear on the list.

Some approvals may change over time. You can check the most current status at danfoss.com or contact your local Danfoss representative if you have any questions.

Certificates, declarations, and approvals

Table 43: Certificates, declarations, and approvals

Regulatory and Compliance	Directive / Document topic	Standards	Country - Marking
Electrical Safety (Incorporated Control for use in Class I or Class II equipment)	Low Voltage Directive: 2014/35/EU	EN IEC 60730-2-9:2019, EN IEC 60730-2-9:2019/A1:2019, EN IEC 60730-2-9:2019/A2:2020, EN 60730-1:2016, EN 60730-1:2016/A1:2019, EN 60730-1:2016/A2:2022	Europe - CE
Electrical Safety (control is validated to use as Incorporated)	Recognized Component	UL 60730-1 - 2009 - Revision 2014, UL 60730-2-9 : 2010, Revision : 2013	United States - cUR _{US}
Electrical Safety (control is validated to use as Incorporated)	Recognized Component	CSA E60730-1 :2013, CSA E60730-2-9 : 2001, Revision : 2008, AMD 1	Canada - cUR _{US}
Electrical Safety (Incorporated Control for use in Class I or Class II equipment)	-	GB 14536.1:2008, GB 14536.10:2008	China - CQC
Electrical Safety & Electromagnetic Compatibility	Supplier Declaration of Conformity (SDoC)	EN 60730-1:2016, EN 60730 2-9:2019, EN 610006-2:2005 & EN 61000-6-3:2007+A1:2011	Ukraine - UA
Electrical Safety	Certification of Conformity (CoC)	CU TR 004/2011	Eurasia - EAC
Electromagnetic Compatibility	EMC Directive: 2014/30/EU	EN 610006-2:2005 & EN 61000-6-3:2007+A1:2011	Europe - CE
RoHS	RoHS Directive: 2011/65/EU & 2015/863/EU	EN IEC 63000:2018	Europe - CE
Food Safety	Food Equipment	NSF/ANSI standard 2	United States
Approved for use in Flammable Refrigerants	Enclosed Break Device / sealed device nC (Relays)	Sealed Device "nC" IEC 600079-15:2017, Enclosed-Break device "dC" IEC 60079-1:2014, clause 15.5.3	Europe
Approved for use in Flammable Refrigerants	Enclosed Break Device (Relays)	Sealed device "nC" UL 60079-15 and CAN/CSA C22.2 No. 60079-15, Enclosed-Break device "dC" IEC 60079-1:2014, clause 15.5.3	US and Canada
Enclosure Material Flammable Class	-	UL 94, V-0	US
HACCP, Temperature Measuring probe in compliance with EN13485 Class I, when used with AKS 12 sensor	-	EN 13485:2001	Europe
Certification and Manufacturer Declarations on Conformity	CE, cUR _{US} , CQC, UA, EAC, NSF, RoHS		

Online support

Danfoss offers a wide range of support along with our products, including digital product information, software, mobile apps, and expert guidance. See the possibilities below.

The Danfoss Product Store



The Danfoss Product Store is your one-stop shop for everything product related—no matter where you are in the world or what area of the cooling industry you work in. Get quick access to essential information like product specs, code numbers, technical documentation, certifications, accessories, and more.

Start browsing at store.danfoss.com.

Find technical documentation



Find the technical documentation you need to get your project up and running. Get direct access to our official collection of data sheets, certificates and declarations, manuals and guides, 3D models and drawings, case stories, brochures, and much more.

Start searching now at www.danfoss.com/en/service-and-support/documentation.

Danfoss Learning



Danfoss Learning is a free online learning platform. It features courses and materials specifically designed to help engineers, installers, service technicians, and wholesalers better understand the products, applications, industry topics, and trends that will help you do your job better.

Create your Danfoss Learning account for free at www.danfoss.com/en/service-and-support/learning.

Get local information and support



Local Danfoss websites are the main sources for help and information about our company and products. Find product availability, get the latest regional news, or connect with a nearby expert—all in your own language.

Find your local Danfoss website here: www.danfoss.com/en/choose-region.

Danfoss A/S

Climate Solutions • danfoss.com • +45 7488 2222

Any information, including, but not limited to information on selection of product, its application or use, product design, weight, dimensions, capacity or any other technical data in product manuals, catalogues descriptions, advertisements, etc. and whether made available in writing, orally, electronically, online or via download, shall be considered informative, and is only binding if and to the extent, explicit reference is made in a quotation or order confirmation. Danfoss cannot accept any responsibility for possible errors in catalogues, brochures, videos and other material. Danfoss reserves the right to alter its products without notice. This also applies to products ordered but not delivered provided that such alterations can be made without changes to form, fit or function of the product.

All trademarks in this material are property of Danfoss A/S or Danfoss group companies. Danfoss and the Danfoss logo are trademarks of Danfoss A/S. All rights reserved.